

**Verslag van het college van geneesheren
RADIOTHERAPIE-ONCOLOGIE
contract 1 januari 2011 – 31 december 2011**

**Rapport du collège de médecins
RADIOTHERAPIE- ONCOLOGIE
contrat 1 janvier 2011- 31 décembre 2011**

Prof. Pierre Scalliet
Voorzitter-Président

Inhoudstafel

Deel 1: Werking van het college van radiotherapeuten	3
A/ inleiding	4
B/ organisatie van het college van radiotherapie-oncologie	5
C/ plenaire vergaderingen	7
Deel 2: Resultaten	13
1. Alanine Dosimetry	14
2. Procare	31
3. Incident reporting	49
4. IMRT physics	51
5. Audits	88

DEEL 1

WERKING VAN HET

COLLEGE VAN RADIOTHERAPIE-

ONCOLOGIE

A/ Inleiding

De commissie Peer Review voor Radiotherapie-oncologie werd, op initiatief van het Ministerie van Volksgezondheid, in 1995 opgericht en bestaat uit radiotherapeuten en fysici. De doelstelling van deze commissie is de kwaliteit van de bestralingsbehandelingen trachten te verbeteren door het organiseren van peer review activiteiten.

In mei 2000 werd het college van geneesheren radiotherapie geïnaugureerd.

In september 2000 werd overgegaan tot een formele integratie van het door het ministerie benoemde college enerzijds en de reeds sinds 1995 bestaande commissie Peer Review voor Radiotherapie-oncologie anderzijds.

In juli 2003 werd een nieuw college geïnstalleerd, na verschijnen in het staatsblad (KB 30-7-2003).

In 2006 werd opnieuw een nieuw college samengesteld (KB 15-12-2006), de samenstelling vindt u onder B/.

In **2011** verschillende projecten gewerkt:

- 1. ALANINE DOSIMETRIE**
- 2. Procure**
- 3. Incident Report Systems**
- 4. IMRT**
- 5. Audits**

De stand van zaken van deze verschillende projecten vindt U in deel 2 van dit verslag.

In maart 2011 ging de jaarlijkse vergadering van het college en de diensthooften van alle Belgische radiotherapie centra door. Op deze vergadering zijn ook de fysici aanwezig. Feedback werd gegeven over de uitgevoerde projecten, en de planning voor 2011-2012 werd voorgesteld en besproken.

B/ Samenstelling van het college van radiotherapeuten-oncologen

Leden van het college in de periode 2000-2003 (KB 10/6/1999):

Prof. P. Vanhoutte (voorzitter)
Dr. P. Huget (ondervoorzitter)
Prof. C. Weltens (contactpersoon en secretaris)
Dr. G. Demeestere
Dr. W. Deneve
Dr. D. Marchal
Prof. P. Scalliet
Dr. K. Vandeputte

Leden van het college in de periode 2003-2006 (KB 30/7/2003)

Dr. P. Huget (voorzitter)
Prof. P. Scalliet (ondervoorzitter)
Prof. C. Weltens (contactpersoon en secretaris)
Prof. J.M. Deneufbourg
Dr. D. Marchal
Dr. P. Spaas
Dr. K. Vandeputte
Dr. L. Vanuytsel

Huidige samenstelling van het college (KB 15/12/2006)

Prof. P. Scalliet (voorzitter)
Dr. P. Spaas (ondervoorzitter)
Prof. C. Weltens (contactpersoon en secretaris)
Dr. C. Mitine
Dr. K. Vandeputte
Dr. D. Van den Weyngaert
Dr. L. Vanuytsel († 30-8-2008)

Naast de door het ministerie aangestelde leden, wordt het college sinds zijn installatie vervoegd door experts (fysici, verpleegkundigen en radiotherapeuten).

In 2011 was de samenstelling van de commissie van experts als volgt:

radiotherapeuten

Prof. P. Vanhoutte
Dr. J. Vanderick
Dr. P. Huget
Prof. Y. Lievens (voorzitter VBS)
Dr. P. Bulens (voorzitter BVRO)

physici

A. Rijnders
F. Vanneste
M. Van Dycke
Prof. D. Verellen
K. Feyen (voorzitter BVZF/BSPH)

verpleegkundigen

G. Vandavelde
P. Bijdekerke
S. D'Haese (voorzitter VVRO)

C/ Plenaire vergaderingen

Volgende plenaire vergaderingen werden gehouden in 2011:

DATUM
01-03-2011
31-05-2011
11-10-2011

De verslagen van bovenstaande vergaderingen zijn in dit jaarverslag geïncludeerd, u vindt ze op de volgende pagina's.

Minutes of the meeting of 01-03-2011

provisional report

Present:

College: P. Scalliet, C. Weltens, D. Van den Weyngaert, K. Vandeputte,
Experts radiation oncologists: J. Vanderick, P. Van Houtte, P. Huget
Experts physicists: F. Vanneste, A. Rijnders, M. Van Dycke, D. Verellen
Invited:

1. K. Feyen for the BVZF
2. Guy Vandeveldel, P. Bijdekerke for the VVRO

Apologized: Y. Lievens, P. Coucke, S. D'Haese, C. Mitine, P. Spaas

Approval of the minutes of the previous meeting

The minutes are approved.

Briefing BVRO and VBS

A possible fusion of BVRO/ABRO and VBS/GBS is for the moment under discussion. The financial and legal consequences are being studied.

Beldart

Measurement are on schedule. "Classical" RT treatments are measured, however IMRT and Tomotherapy treatments are not for currently not measured, but measurement techniques are under evaluation (for V-Mat, Rapid Arc, ...). Funding is a problem.

QMS

1. Incident Reporting System

1. This is not ACCIDENT reporting. ACCIDENT reporting has to be done (FANC), however the legal framework is not clear. P. Scalliet is investigating the European situation.
2. The PRISMA RT system is proposed for incident reporting. Funding for implementation in all radiotherapy departments is provided by the Cancer Plan.
3. The aim is to provide a tool for incident analysis within each department, however anonymised benchmarking on a national level is also possible (though not mandatory).

2. On Site Visits and Audits

4. Training of the auditors on 11-12 March
5. 5 teams will be trained
6. Each year 5 hospitals (5 radiotherapy departments) will be audited
7. 2011: Namur, Turnhout, Liege, Hasselt and Verviers
8. Departments will receive a report, no certification!
9. The individual reports belong to the college (auditors) and the department itself, they will not be made public, nor communicated to official bodies. It are confidential data, they are not dissiminated. A general report with (anonymised) general remarks will be made for the college.

Quality Indicator project

On hold for practical reasons: website failure

QA IMRT physics project

A new questionnaire is under development

Acquilab

successful project, more than 400 cases have been reviewed.

Brachytherapy Prostate Cancer

1.400.000 Euro has to be saved on the cost for prostate brachytherapy. This will be discussed with the VBS. This will also be discussed on the meeting of the heads of department. Marc Brosens and Yolande Lievens are involved in the discussions.

"Diensthoofdenvergadering"

The meeting of the college with the heads of departments is planned on March 18th.

Next Meeting:

31-5-2011, Arenberg, 19.00

C. Weltens 28-5-2011

Minutes of the meeting of 31-05-2011

provisional report

Present:

College: P. Scalliet, C. Weltens, K. Vandeputte, C. Mitine, P. Spaas

Experts radiation oncologists: J. Vanderick

Experts physicists: F. Vanneste, A. Rijnders, M. Van Dycke, D. Verellen

Invited:

4. K. Feyen for the BVZF
5. Guy Vandevelde, P. Bijdekerke for the VVRO
6. Renaat Van den Broeck for the HUB

Apologized: P. Van Houtte, Y. Lievens, P. Coucke, S. D'Haese, D. Van den Weyngaert, P. Huget

Approval of the minutes of the previous meeting

Addition to point 2. The fusion of BVRO and VBS will not take place. The legal structure of the 2 organisations is not compatible.

Addition to point 4. Incident reporting: P. Scalliet has investigated the situation in European countries with respect to the declaration of accidents. Only in France this is mandatory. From other countries he did not receive an answer. In Belgium the situation remains unclear: on one hand you are never obliged to incriminate yourself, on the other hand if you do not declare this can be used against you.

Briefing BVRO and VBS

"staten general" : all machine suppliers were present

Beldart

Bob Schaeken will defend his thesis on June 28th, in the "promotiezaal of the VUB" in Etterbeek.

Future project: alanine dosimetry for tomotherapy treatments

QMS

1. Incident reporting system

Since the funding for this system is directly given to the hospitals (not to the college), the radiotherapy departments have to decide how to proceed:

1. The hospital has his own incident reporting system and the radiotherapy department uses this system
2. The hospital has his own incident reporting system but the radiotherapy department prefers to use PRISMA
3. The hospital has no incident reporting system and the radiotherapy department uses PRISMA

PS will communicate this to the different radiotherapy departments.

2. On Site Visits: AUDITS

The training of the auditors was successfully completed in March 2011. Karen Feyen is the coordinator of the audits, and she will send the different presentations to the auditors.

Luxembourg also wants to be audited: will be planned (PS, GVDV, KV, KF, PB).

The audits will start in September 2011. The auditors will be divided into 5 groups of 3 auditors, each group will audit 1 hospital. In each group 1 experienced auditor will be responsible (PS, YL, SV, GVDV, MVD).

Luxembourg also wants to be audited: will be planned as first audit (PS, GVDV, KV, KF, PB).

IMRT questionnaire

A new questionnaire (MVD) is planned on the methodology and tolerances of IMRT.

The alanine phantom will be used to check IMRT treatments.

Prostate brachy

This project still exists, but only small numbers of patients are registered

Procure

This project runs well, 500 cases have been reviewed. An abstract was proposed on ESTRO

Formation of nurses and technologists:

Renaat Van den Broeck informs us on the actual situation of the formation of nurses (postgraduaat radiotherapie) and technologists in the HUB (Hogeschool Universiteit Brussel)

1. Postgraduaat radiotherapie

Each year about 12 students follow this postgraduate course in radiotherapy. 20 studypoints.

2. TMB = Technoloog Medische Beeldvorming

In this training, students can choose for a specialization in radiotherapy (choose among nuclear medicine, CT, NMR, cardio and radiotherapy). This specialization takes 13 weeks.

3. BANABA oncological nurse

Possibility is offered to include this 13 weeks of specialization in radiotherapy.

The attention is drawn to the fact that although TMBs are formed, they cannot officially operate in a radiotherapy department. The college fully understands the problem and agrees to support the necessary changes in the law. The college suggests that the VVRO takes action which is then supported by the college/bvro/bvzf.

Joined meeting between VVRO-BVRO-BVZF should be planned in the spring of 2013, the annual meetings of the different societies should take place as usual not to interfere with the sponsoring of the different societies!

Weltens Caroline
02-06-2011

NEXT MEETING: 20 September 2011

Minutes of the meeting of 11-10-2011

provisional report

Present:

College: P. Scalliet, C. Weltens , K. Vandeputte, P. Spaas, D. Van den Weyngaert

Experts radiation oncologists: J. Vanderick, P. Van Houtte, P. Huget

Experts phycisists: F. Vanneste, A. Rijnders, M. Van Dycke, D. Verellen,

Invited:

7. K. Feyen for the BVZF
8. Guy Vandavelde for the VVRO
9. Renaat Van den Broeck for the HUB
- 10.Y. Lievens for the VBS
- 11.B. Schaeken for Beldart

Apologized: S. D'Haese, C. Mitine, P. Bijdekerke

Approval of the minutes of the previous meeting

Briefing BVRO and VBS

Beldart

Dosimetry in Belgian radiotherapy depts. And alanine dosimetry for tomotherapy treatments

QMS

- Incident reporting system
- On Site Visits: AUDITS

IMRT questionnaire

A new questionnaire (MVD) is planned on the methodology and tolerances of IMRT.

The alanine phantom will be used to check IMRT treatments.

Procare

This project runs well, 500 cases have been reviewed. An abstract was proposed on ESTRO

Weltens Caroline
23-1-2012

NEXT MEETING: January 2012

DEEL 2:
RESULTATEN

1. Alanine dosimetry of the radiotherapy machines in Belgium

**Belgian Dosimetry Audits in
Radiotherapy (BELdART): 2009-2011**

**Final Report of an external audit of basic dosimetry of
radiation devices for external radiotherapy in Belgium**

Members of the steering committee:

**Alex Rijnders (College van Geneesheren), Francois Sergent (BVZF), Dirk Verellen (College van Geneesheren), Stelaan
Vynckier (BVZF); NuTeC: Bob Schaeken, Wouter Schroeyers, Sonja Schreurs, Robin Cuypers .**

1. M & M's: measurement set up

"BELART 2009-2011 : monitors beam dosimetry quality (basic parameters)

"Basic" mechanical check: isocentrum; lasers; telemeter; light field correspondence

"Basic" dosimetry check: dose measurements in water on beam axis
at pre-defined depths

- photon beams: 11 dose measurements all types
- electron beams: 2 dose measurements in reference conditions

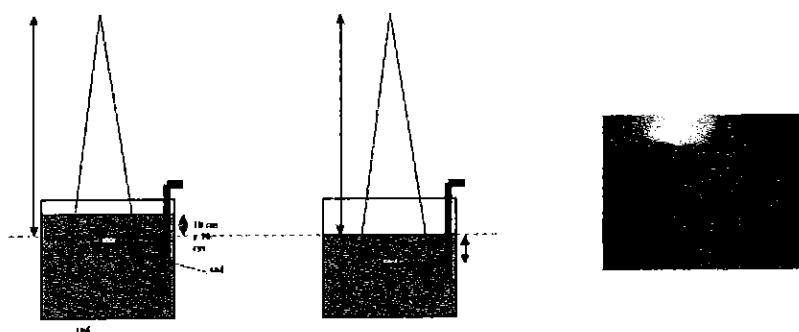

1. M & M's: Uncertainty budget (4 Harwell detectors; 5 rotations)

Base function detectors (25 Gy):

Dose (primary standard)	0.30%
Amplitude: (A_D)	0.12%
Mass: ($\approx 50 \mu\text{g}$)	0.04%

Field detector (4 Gy):

Amplitude: (A_D ; 30 mGy = worst case)	0.75%
Mass: ($\approx 50 \mu\text{g}$)	0.04%

Experimental conditions:

Fading:	0.02%
Irr. temp:	0.03%
Beam quality:	0.27%
Positioning	0.04%
<u>Encapsulation</u>	<u>0.50%</u>

Combined standard uncertainty	1.00% : 4 Gy, 4 pellets in γ
	2.04% : 4 Gy, 4 pellets in β

1. M & M's: Dosimetry audits: action levels

The relative deviation $|\delta| \equiv |(D_{measured} - D_{center}) \times 100 / D_{center}|$ is classified into four levels with respect to actions to be taken:

- o "within optimal level": $|\delta| \leq 3\% \rightarrow 3\sigma$!!
- o Out of optimal level but "within tolerance level": $3\% < |\delta| \leq 5\%$
- o "out of tolerance level": $5\% < |\delta| \leq 10\%$
- o "alarm level": $|\delta| > 10\%$.

4

Status per Jan. 2012: number of clinical linacs in operation in Belgium

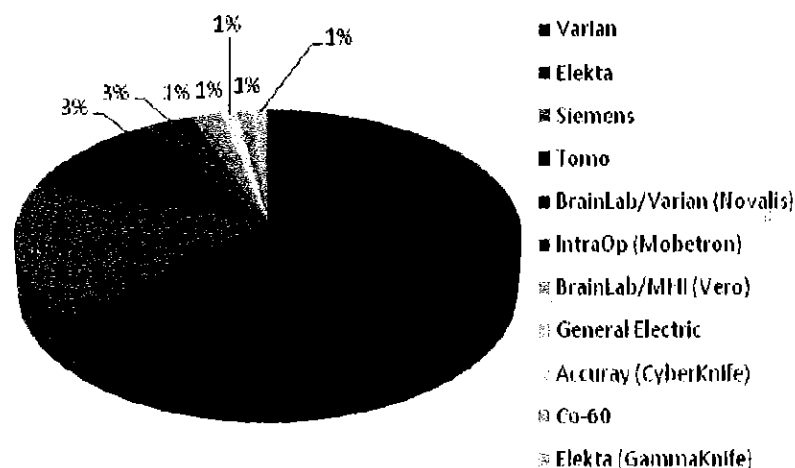

91 linacs, installed at 26 radiotherapy centres over 35 sites

74 "standard" linacs + 17 "dedicated"

5

Status per Jan. 2012: year of installation

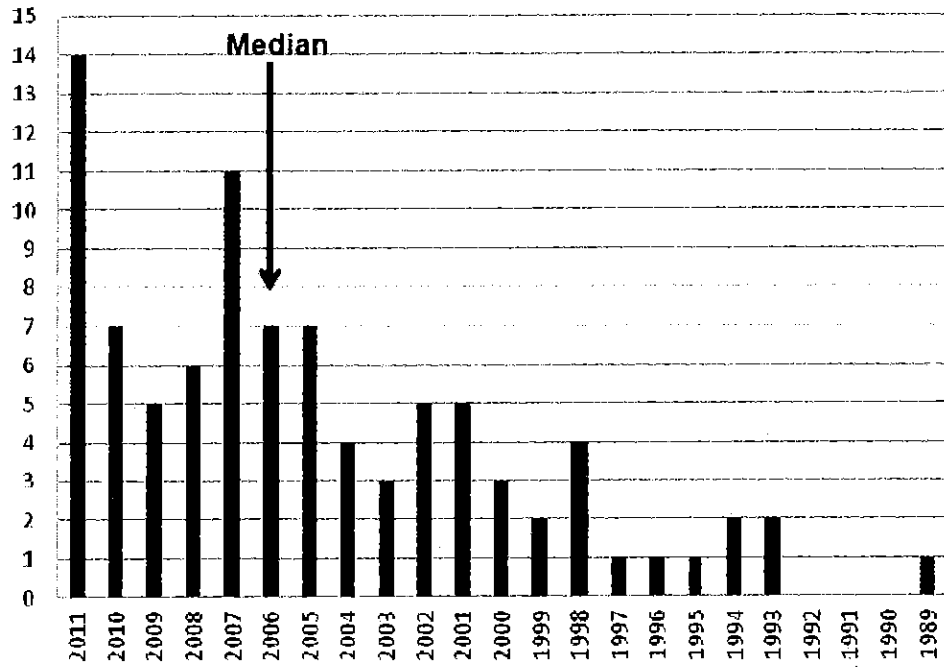

- Varian
- Elekta
- Siemens
- BrainLab/MHI
- General Electric
- BrainLab/Varian

Varian	23
Elekta	21
Siemens	14
BrainLab/MHI	1
General Electric	1
BrainLab/Varian	1
Total =	61

261 beams financed => 61 doses

excl. 7 TomoTherapy, 3 Mobetrons, 1 GammaKnife, 1 CyberKnife

3. Status of BELdART I (feb. 2009- sept. 2011) :

61 linacs: Varian: 22;
 Siemens: 14;
 Elekta: 22;
 Novalis: 1;
 BrainLabAB/MHI "Vero": 1;
 General Electric: 1

Dosimetry was checked in

112 photon beams: 6x 4MV; 1x 5MV; 49x 6MV; 4x 10MV; 21x 15MV;
 18x 18MV; 3x 23MV

110 electron beams: 3x 4MeV; 1x 5MeV; 25x 6MeV; 1x 7MeV; 7x 8MeV; 8x 9MeV;
 10x 12MeV; 2x 14MeV; 11x 15MeV; 2x 16MeV; 14x 18MeV;
 5x 20MeV; 1x 25MeV

For 2nd run measurements in photon beams:

$$D_{\text{meas}} / D_{\text{stated}} = 1.001, \sigma = 0.014 \text{ (#1342)}$$

$$D_{\text{alanine}} / D_{\text{ionometry}} = 1.003, \sigma = 0.009 \text{ (#192)}$$

2. Results: survey on dose protocols and ionisation chambers

used protocols		ionisation chambers		periodicity chamber calibration	
photon beams		photon beams			
#	%	#	%	#	%
NCS18(2008)	23 42	Nuclear Enterprise	18 33	within 2 y	10 33
NCS2(1986)	21 38	PTW	21 38	within 3 y	5 17
HPA(1985)	2 4	IBA	16 29	within 4 y	5 17
IAEA TRS 398(2000)	9 16			5 y	2 7
electron beams		electron beams		6 y	5 17
#	%	#	%	7 y	3 10
NCS18(2008)	16 36	Nuclear Instruments	2 5		
NCS5(1989)	14 31	PTW	36 84		
IAEA TRS 398 (2000)	13 29	IBA	5 11		
IAEA TRS 381 (1987)	1 2				
TG-51	1 2				

2. Results: geographical dispersal

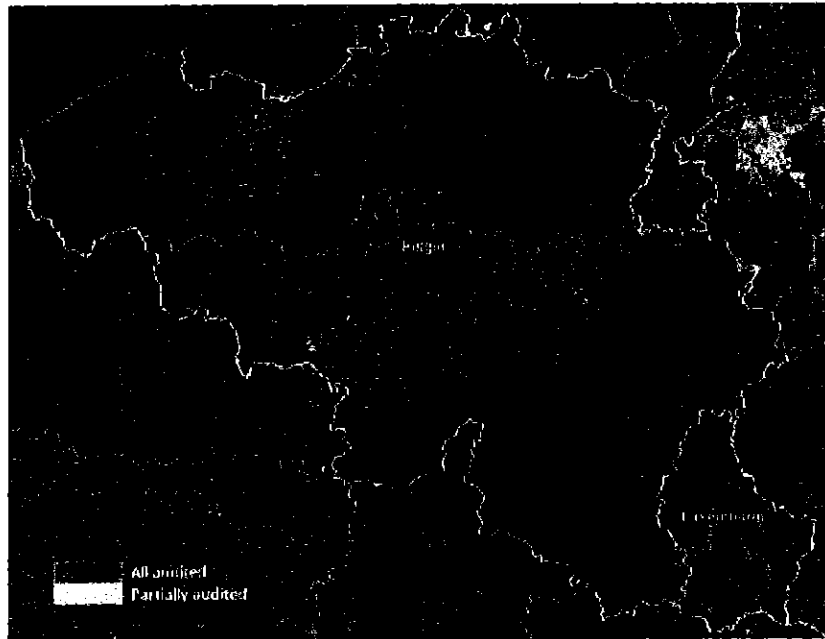

10

2. Results: Traceability in photon beams (BHPA): reference beams



$D_{w, \text{alanine}} / D_{w, \text{ionisation chamber}} : \text{ref beams}$

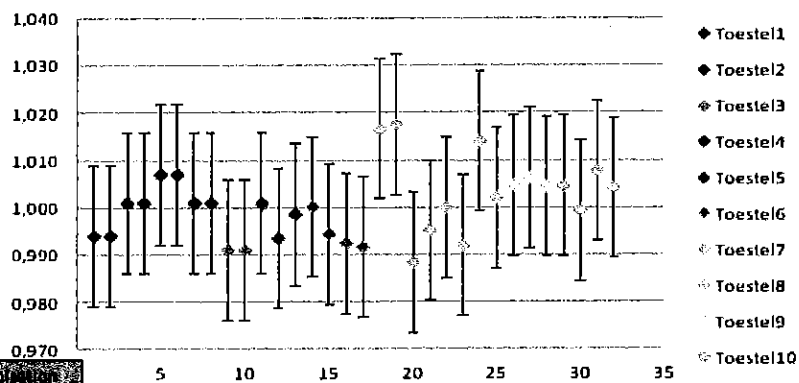

N =	28
mean =	1,000
σ =	0,008
range =	0,029

11

2. Results: Traceability in electron beams (BHPA): reference beams

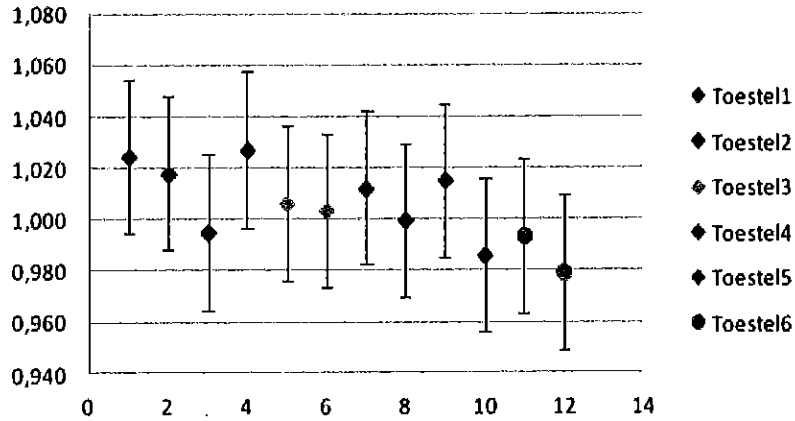

12

2. Results: Traceability in photon beams (BHPA): ref and non reference

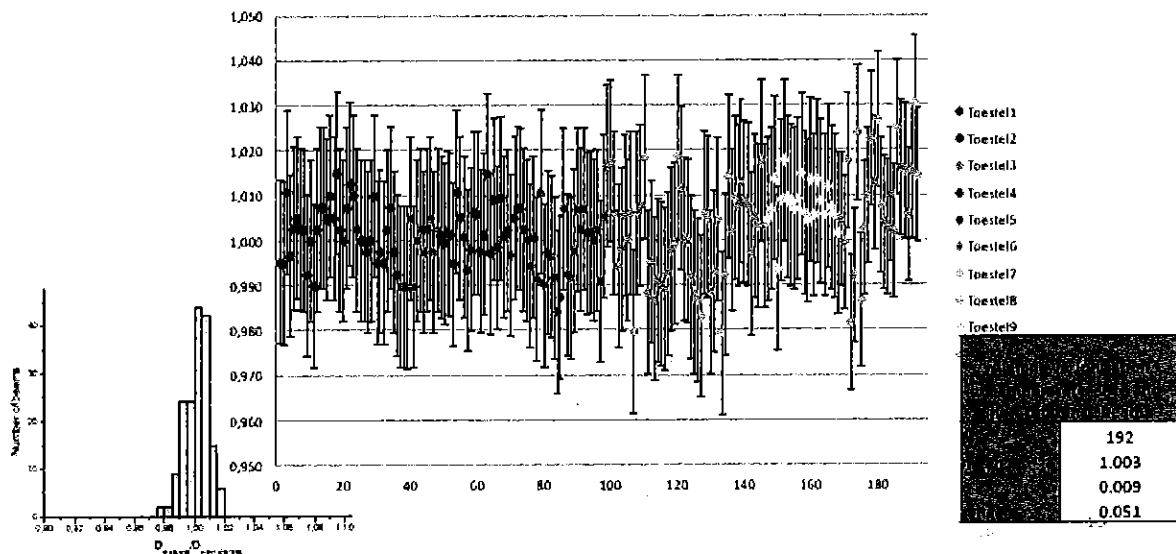
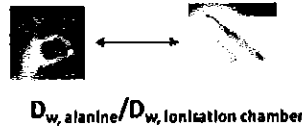

2. Results of tests: irregular field openings

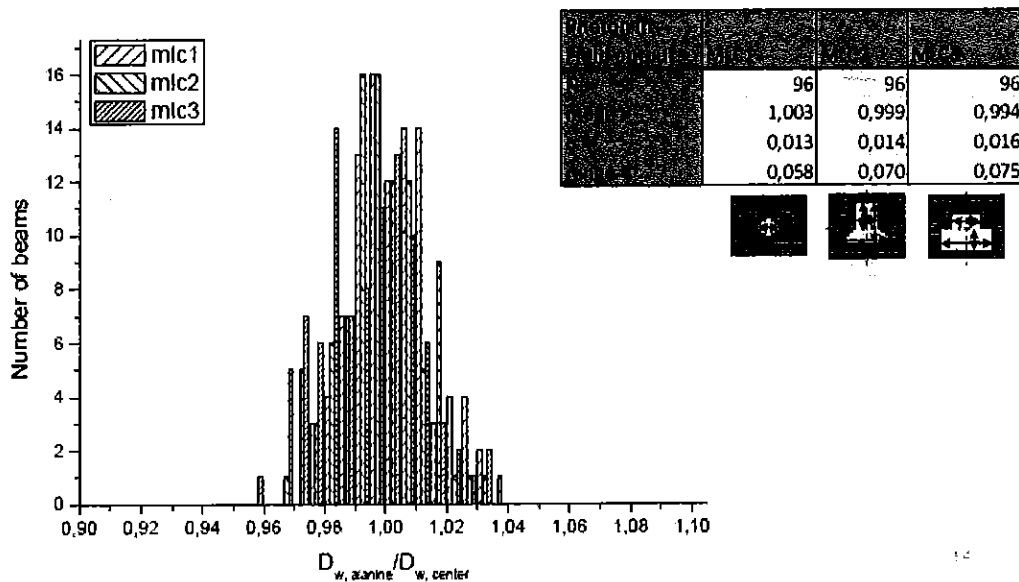

2. Results of tests: high-energy electron beam output

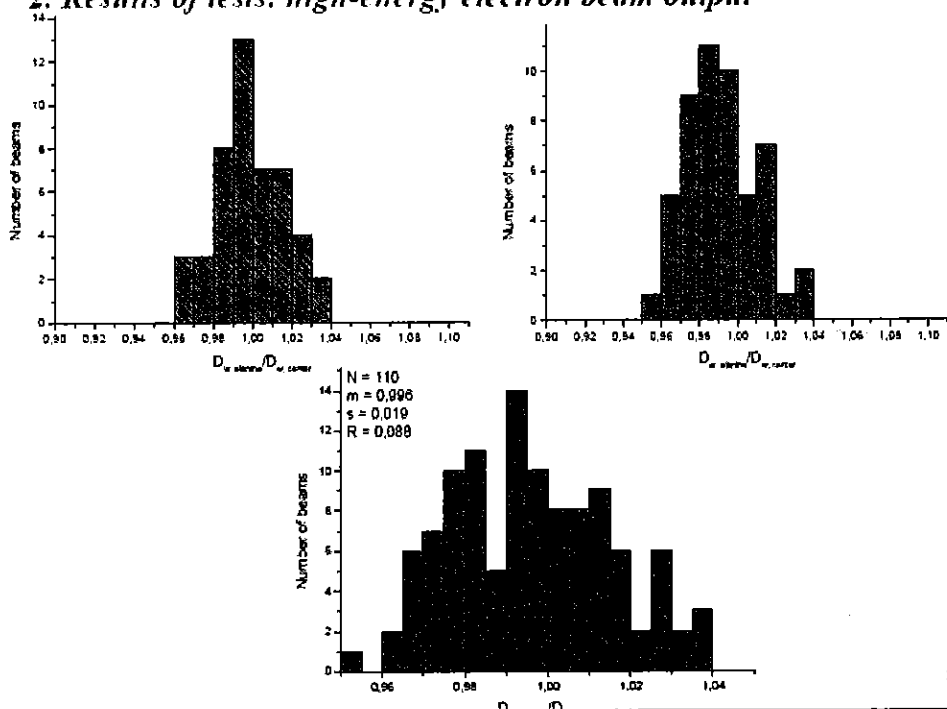

2. Results of tests: summary (< Feb. 2012)

Tests & class of tests	#meas	mean D _{95%} /D _{50%}	1 σ	flag	max	min	confidence limit Δ
All photon beams	1342	1.001	0.014	0.390	1.045	0.655	2.17
All low energy photon beams	728	1.000	0.014	0.090	1.045	0.955	2.10
All high energy photon beams	613	1.002	0.014	0.073	1.038	0.965	2.25
10x10@dref	112	1.001	0.012	0.056	1.030	0.974	1.81
10x10@dref Tray	53	1.000	0.012	0.059	1.032	0.973	1.76
10x10@10	102	1.002	0.012	0.056	1.030	0.974	1.90
10x10@20	108	1.002	0.014	0.074	1.036	0.962	2.37
10x10@10 Wedge	106	0.999	0.012	0.073	1.035	0.961	1.90
10x10@20 Wedge	106	1.002	0.018	0.090	1.045	0.955	2.85
6x6@8	112	1.005	0.012	0.051	1.028	0.977	2.27
8x20@8	106	1.002	0.012	0.074	1.040	0.966	2.04
20x8@8	106	1.003	0.013	0.063	1.037	0.974	2.19
20x20@8	110	1.001	0.014	0.076	1.035	0.959	2.13
mlc1@8	106	1.004	0.013	0.058	1.034	0.977	2.29
mlc2@8	106	1.000	0.014	0.070	1.037	0.967	2.12
mlc3@8	106	0.995	0.016	0.075	1.033	0.957	2.89
All mlc measurements	318	1.000	0.015	0.080	1.037	0.957	2.24
All open field measurements	757	1.002	0.013	0.084	1.040	0.956	2.12
All wedged measurements	212	1.001	0.015	0.090	1.045	0.955	2.36
QI	115	0.999	0.010	0.054	1.021	0.967	
All electron beams	110	0.996	0.019	0.088	1.038	0.950	3.27
All low energy electron beams	52	1.000	0.018	0.074	1.037	0.963	2.75
All high energy electron beams	58	0.993	0.020	0.088	1.038	0.950	3.69

16

2. Results: summary (< Feb. 2012)

Ref.	period	system	beam energy	D_{meas}/D_{ref}	1s	# meas	remarks
Joh86	< 1985	Farmer/ NACP	^{60}Co	1.001	0.019	59	ref cond
			^{60}Co	0.999	0.021	51	non ref cond
			MV	1.025	0.029	62	sealed IC
			MeV	0.995	0.017	59	scatter filter
Ize00	1969-1998	TLD	all photon beams	1.013	0.088	3307	
			all photon beams	0.994	0.021	235	ref cond
Fer00	1998	TLD		1.001	0.014	1342	
			QI	0.996	0.015	217	
				0.999	0.010	115	
			coll opening	1.003	0.018	642	regular field size
				1.002	0.013	757	
			wedged beams	1.006	0.130	208	regular field size
	1.001	0.015	212				
		wedge transmission	1.007	0.100	405		
Bla02	1993	Farmer/pp	all photon beams	1.001	0.007	10	In phantom/ regional
			all electron beams	1.004	0.014	34	in phantom/ regional
Kro03	1997-2001	TLD	all photon beams	0.996	0.028	362	incl off axis/ national
			wedged beams	1.000	0.027	122	incl off axis/ national

2. Results: treatment planning systems used

deviations ≈ ? TPS used ... (RPC -2010)

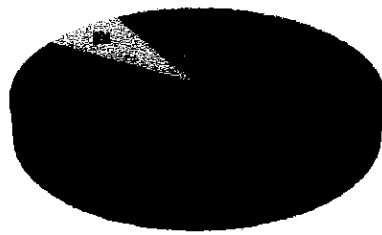

- Pinnacle
- Eclipse
- CMS XiO
- Isogray
- Bscan, IPlan

TPS	NUMBER
Pinnacle	27
Eclipse	24
CMS XiO	5
Isogray	3
Bscan, IPlan	2

not in our case... (BELLAART)

2. Results: of mechanical tests

Test	Number Checked	Acceptable	Small Deviation	Large Deviation
Validation of the isocentre	61	60	1	0
Validation of the optical distance indicator	59*	59	0	0
Validation of the position of the laser lines	60**	60	0	0
Correspondence of light and irradiation field	61	60	0	1

2. Results: all photon beams

1st run measurements

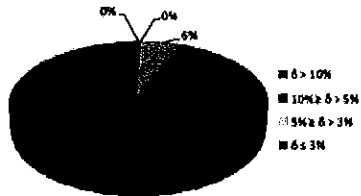

	1	0,1
	4	0,3
	80	5,9
	1270	93,7

2nd run measurements



	0	0,0
	0	0,0
	44	3,3
	1296	96,7

20

2. Results: all electron beams

1st run measurements

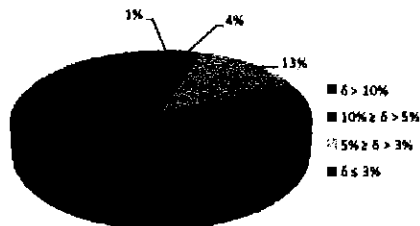

	1	1,0
	4	4,1
	13	13,3
	80	81,6

2nd run measurements

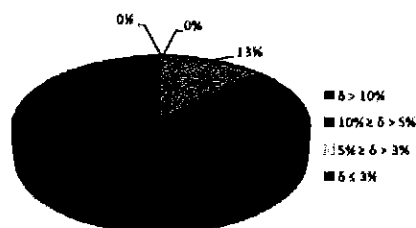

	0	0,0
	0	0,0
	14	12,7
	96	87,3

21

6. casus: auditing all clinical beams

0.78	0.01	-0.11	0.37	-1.26	-0.12	0.44	1.73	0.28	0.11	1.86	1.34	0.28	Toestel 1 (4MV)
-0.04	-0.04	-0.11	-0.07	-0.65	0.94	1.55	-0.81	-0.16	0.34	0.84	-0.15	-0.45	Toestel 2 (6MV)
-1.39	-1.07	-2.29	-0.82	-1.03	-0.07	-1.62	-0.97	-0.97	-1.93	-0.46	-1.21	-0.45	Toestel 2 (15MV)
-1.64	-1.01	-1.27	-0.21	-2.40	0.00	-0.42	-1.41	-0.86	-3.18	1.10	-3.25	-1.73	Toestel 3 (6MV)
-0.36	-0.95	-0.36	-0.34	-1.08	-1.40	-0.72	0.05	-0.83	-0.21	0.93	-0.47	-2.03	Toestel 3 (10MV)
-1.71		-2.06	-2.07	-2.22	-2.52	-2.71	-3.31	-2.84	-2.67	-1.24	-2.65	-3.34	Toestel 4 (6MV)
-4.04		-2.92	-2.76	-2.94	-2.01	-3.07	-3.68	-3.57	-3.83	-3.34	-4.12	-3.27	Toestel 5 (15MV)
-0.79		-0.16	0.79	0.19	0.55	-2.33	0.62	0.10	-0.44	0.65	-0.95	-1.78	Toestel 6 (6MV)
-1.87		-2.33	-2.17	-1.99	-1.02	-2.10	-1.21	-0.76	-1.58	-1.62	-2.87	-1.80	Toestel 7 (15MV)
0.52		0.50	1.60	-0.58	-0.48	2.15	0.20	0.30	1.57	-0.72	-0.01	-3.25	Toestel 8 (6MV)
-2.60		-2.60	-3.80	-1.10	-3.60	-0.50	-1.10	-0.60	-0.40	0.50	-0.80	-0.50	Toestel 13 (6MV)
						0.49							(6MV)
2.96	2.77	2.52	2.41	-1.08	-4.23	2.03	4.02	3.31	1.64	3.44	1.61	-2.62	(6MV)
1.62	1.96	1.48	0.93	-1.19	-3.18	2.81	3.80	3.66	3.49	2.31	0.47	-0.90	(15MV)
1.47	1.40	0.37	0.39	-3.87	-1.46	2.76	1.93	2.26	2.18	3.13	0.73	-2.96	(6MV)
2.02	3.17	2.95	3.52	-1.21	-2.46	2.74	1.56	2.47	2.80	2.76	1.89	-3.15	(15MV)

22

6. casus: one centre, 4 locations:

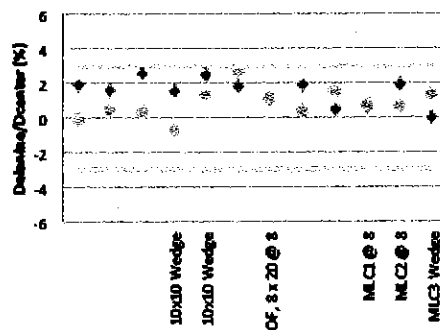
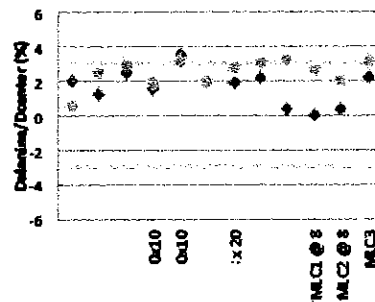
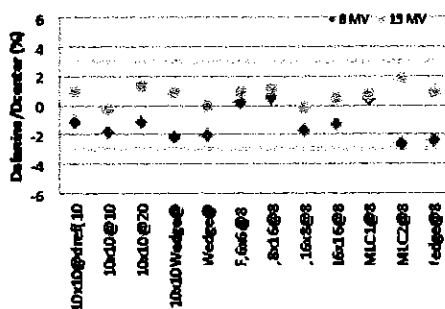

23

3. Discussion: what is the confidence we may have in standard dose deliveries ?

... to judge specific performance with only ONE parameter (Venselaar R&O, 2002):

confidence limit $\Delta = (1\% \text{ devl} + 1.5 \text{ sd})$

$\Delta = 3\%$: if gaussian, $\approx 94\%$ of all measurements are within $\pm 3\%$; $\approx 6\%$ of all individual measurements fall outside this bandwidth (one-sided confidence probability $p = 0.065$)

→ BELdART offers an estimation of the underlimit of Δ

3. Discussion: confidence limit for standard beam axis dose calc. (BELdART)

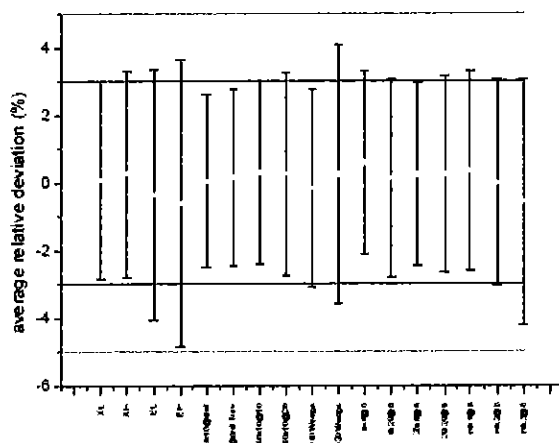

	Δ (%)
X Low	2.3
X High	2.6
E Low	3.1
E High	3.8
10x10@dref	2.0
10x10@dref Tray	2.1
10x10@10	2.3
10x10@20	2.5
10x10@10 Wedge	2.4
10x10@20 Wedge	3.1
6x6@8	2.6
8x20@8	2.3
20x8@8	2.3
20x20@8	2.4
MLC1@8	2.6
MLC2@8	2.3
MLC3@8	3.3
	2.5

BELdART : $\Delta = 2.5\%$

for a single dept.: ... TPS "standard" beams : 2.4% (large asymm) < Δ < 4.0% (asymmetric, missing tissue, inhomogeneity, oblique)

4. conclusions for BELdART-1:

- *alanine/EPR was successfully used as transfer dosimetry system in auditing proven methodology*
the "PTB system" is robust, transferrable and stable in the long run
 - > 15.000 alanine pellets were read out !
 - 13.000 km travelled between 34 locations
- *allows sufficient accurate dose measurements*
- *results into accordance with independent (reference) ionometry*
- *beam (axis) data are well modeled in TPS for the visited centers*

But...

Out of tolerance situations disappear in a 2nd run, a clear explanation is difficult to find...

25

Aim of BELdART-2:

- offering proven technology/ methodology ...
- highly accurate dose measurements in RT
- maintaining expertise and "drive" in the present auditing-work

What BELdART-2 will do:

- BELdART^{Basic}: continuation of beam dosimetry auditing
- BELdART^{Treatment}: end-to-end testing of class specific treatments

"what you see is what you get" ?

the BELdART-2 project remains supervised by effective members of the BHPA on behalf of BHPA and CvGR-CdMR!

27

How will BELdART-2 proceed:

BELdART^{Basic} :

- as BELdART-1 with reduced # tests
- mailed audit, no visitation

BELdART^{Treatment} ; IMRT verifications

- alanine/EMR + EBT2/3 film dosimetry
- we start with intra cranial IMRT treatment
- mailed audit, no visitation

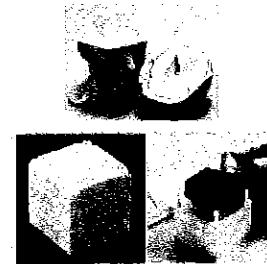

creation/ elaboration of a Belgian Film Dosimetry WG with BHPA

28

Status per Jan. 2012: 91 linacs in operation in Belgium

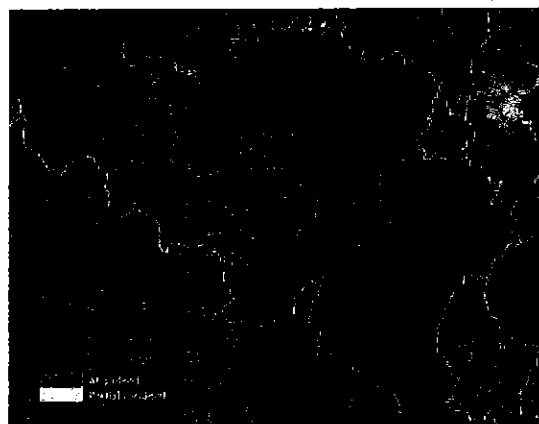

within BELdART-1: 208 beams audited \approx 61 linacs

still 30 linacs need an audit

incl. 7 TomoTherapy, 3 Mobetrons, 1 GammaKnife, 1 CyberKnife

29

Output of BELdART-2:

- further auditing as usual of "new" linacs (mailed; BELdART^{Basic})
- auditing for Tomo, Mobetrou, GammaKnife (and CyberKnife)
- evidence based determination on a national scale of tolerance levels for BELdART^{Treatment}

- IMRT auditing by end-to-end testing (mailed; BELdART^{Treatment})
(irradiate phantom as patient)
- auditing Ir-HDR treatments

- offering a platform of expertise for dosimetry to BHPA members and encouraging discussion in therapy-dosimetry

2. Procure

Prof. Dr. K. Haustermans

Improving rectal cancer care in Belgium by standardizing CTV delineation

The PROCARE RT project

Introduction

- Current status
- Review procedure
- Analysis of results
- Conclusion

- **Current status**
- Review procedure
- Analysis of results
- Conclusion

Brief history

- 2009 Nov – first Aquilab installation
- 2010 March – start of the review with 3 centers
- 2010 April – launch of the official test
- 2010 May – full operation between 10 centers
- 2011 March – 18 centers participating
- 2011 July – 20 centers participating

Clinical guidance

- 2010 March – a CD distributed
 - Procare guidelines
 - A CTV delineation atlas
 - The ESTRO teaching course presentation
 - An OAR delineation atlas
 - The manuscript on CTV delineation

Clinical guidance

- Guidelines for CTV delineation peer reviewed and published
 - A common solution to all
- Guidelines for OAR reviewed by abdominal radiologist (F. Claus)
- Eszter Hortobagyi trained by UZL and half time appointed to Procare project

Delineation guidelines



Int J Radiat Oncol Biol Phys. 2011;81(4):1129-1142. 2011
Copyright © 2011, Elsevier Inc.
Printed in the USA. All rights reserved.
0360-3015/\$ - see front matter

doi:10.1016/j.ijrobp.2011.02.059

CLINICAL INVESTIGATION

Rectum

DEFINITION AND DELINEATION OF THE CLINICAL TARGET VOLUME FOR RECTAL CANCER

SARAH ROELS, M.D.,¹ WIM DUBBOY, M.D.,¹ KAREN HAUDERMANS, M.D., Ph.D.,²
FRÉDY PENNINGCKX, M.D., Ph.D.,¹ VINCENT VANDICAVELLE, M.D.,¹ TOM BOHREBO, M.D.,²
AND WILFRIED DE NEEF, M.D., Ph.D.¹

Departments of ¹Radiology, ²Surgery, and ³Radiology, University Hospital Gasthuisberg, Leuven, Belgium, and ⁴Department of
Radiology, Ghent University Hospital, Ghent, Belgium

Delineation guidelines

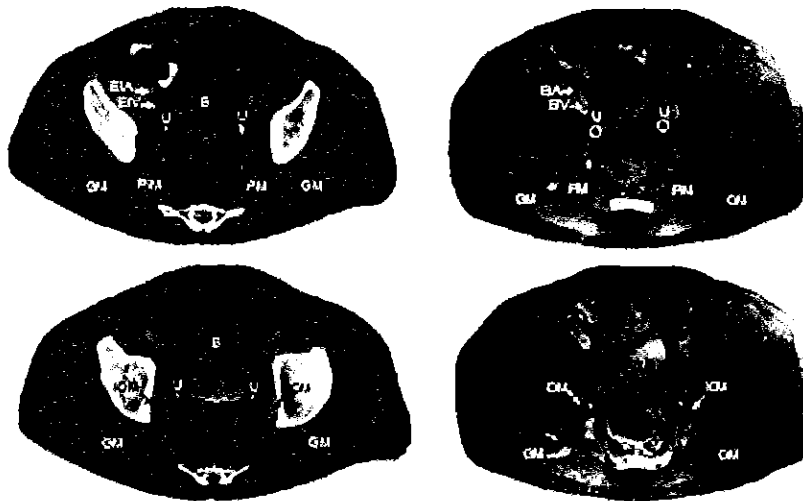

Delineation guidelines for OAR

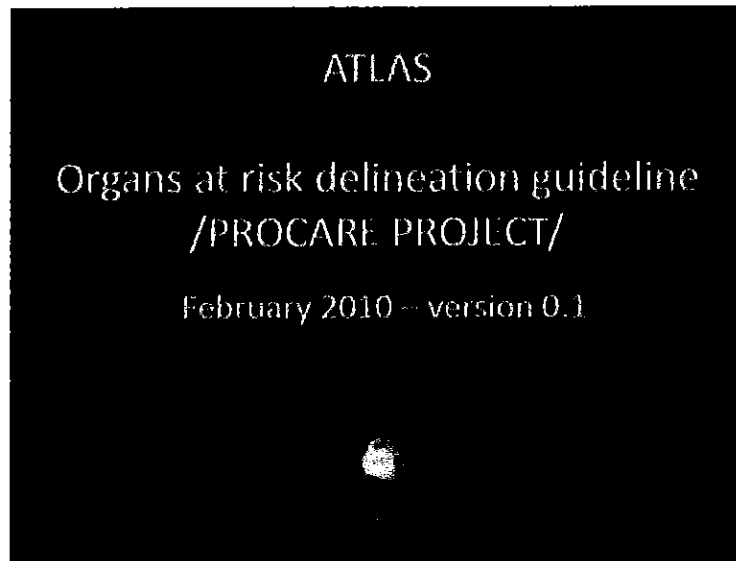

Current situation

- 21 centers agreed to participate in the QA Procure network with Aquilab as platform
- 20 centers have their license installed
- 20 centers have been connected to the network /submitted at least one case/

- Current status
- Review procedure
- Analysis of results
- Conclusion

Structure of the system

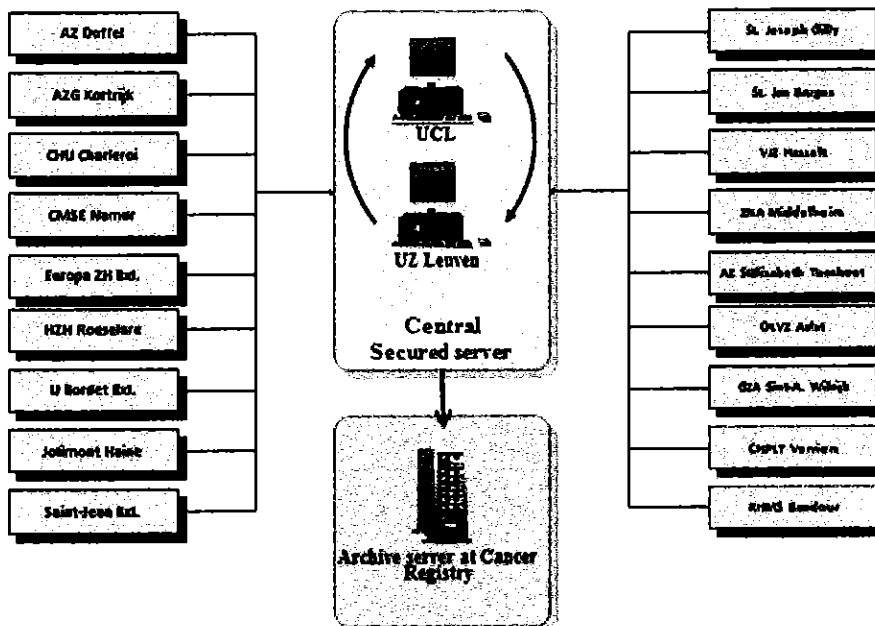

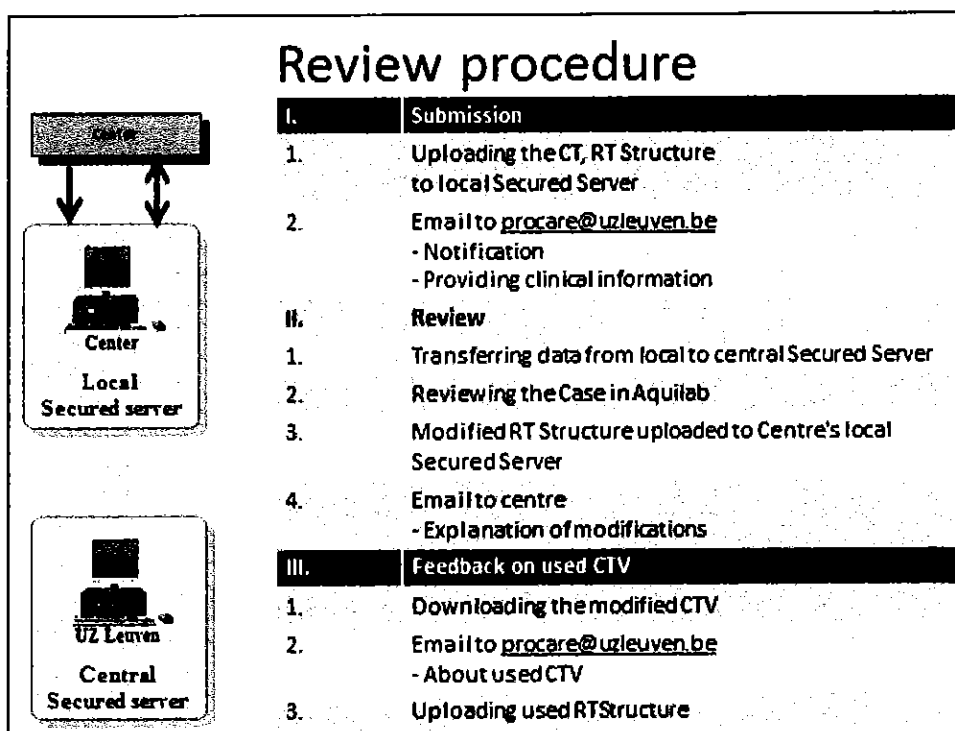

Required information

- Name of the sender hospital
- Identification of the patient
- National registration number -/INSZ-NISS/
- TNM Staging
- Localization of the tumor
- Name of the hospital where the surgery or chemotherapy is planned
- Any further comment

Agreement

- Contours are reviewed within 24 hours
- Modified CTV structures are sent back as "CTV-mod"
- It is not mandatory to implement the modifications!
- Please send back "CTV-used"

Agreement

- Delineation of OAR is not required but highly recommended
- UZ Leuven is checked by UCL and vice versa
- The final database will be archived at the Cancer Registry using national registration number-NISZ/INSS

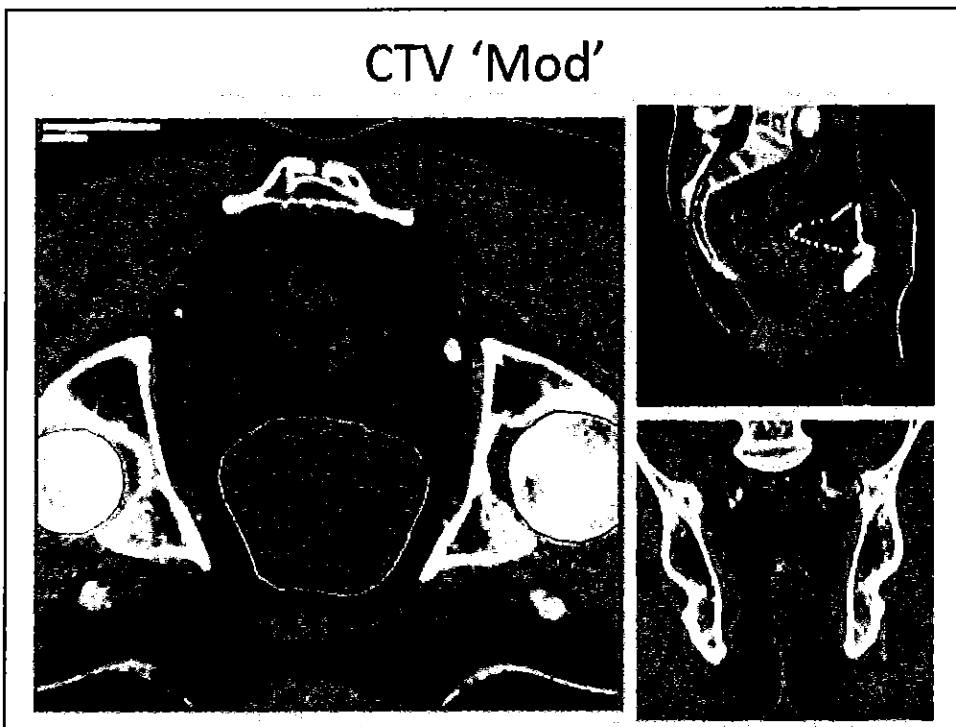
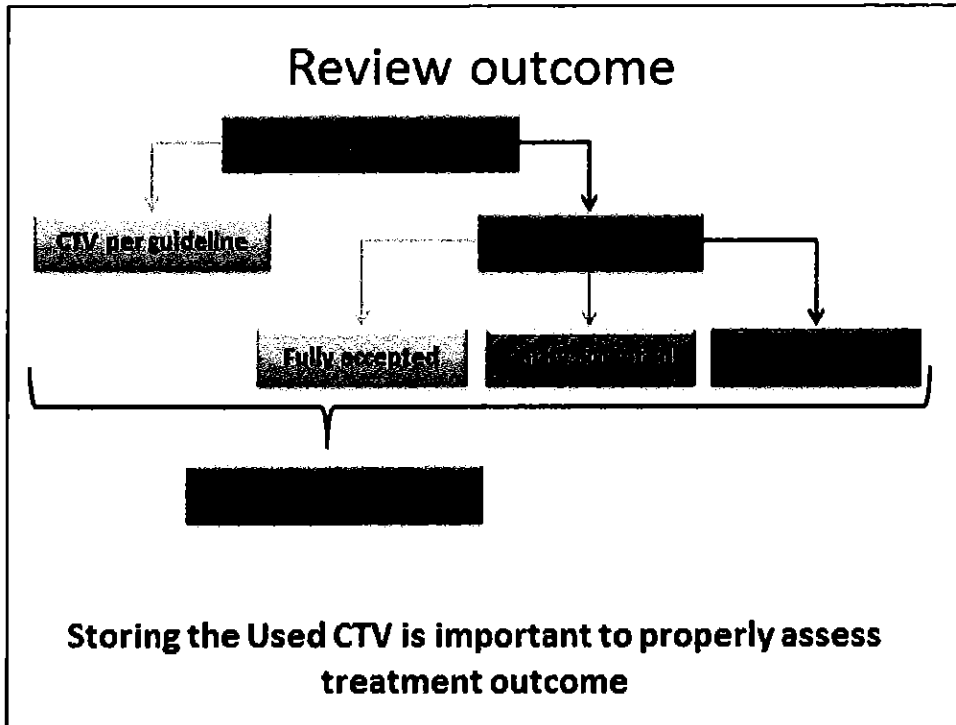

Feedback-CTV 'Used'

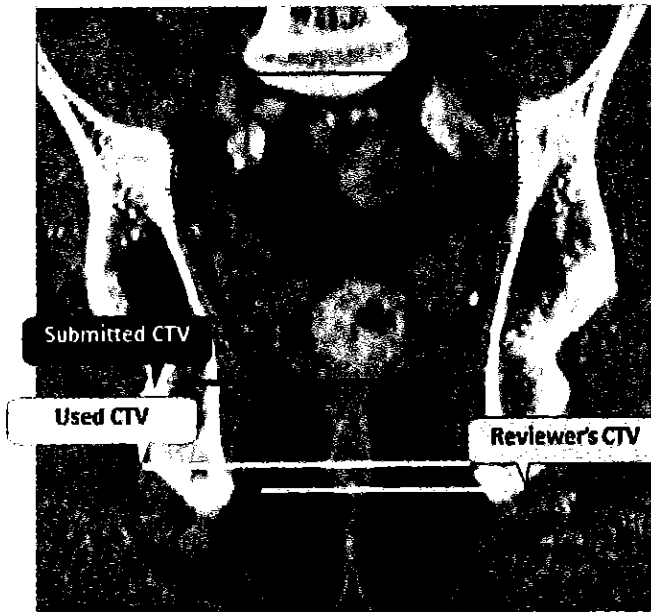

Cases submitted (as of 29-02-2012)

	2010					2011					2012					Grand Total									
	Nov	Apr	May	Jun	Jul	Aug	Sep	Oct	Nov	Dec	Jan	Feb	Mar	Apr	May		Jun	Jul	Aug	Sep	Oct	Nov	Dec	Jan	Feb
Center 1	0	0	4	4	1	3	2	2	3	1	3	3	3	3	2	0	3	0	3	3	4	4	1	62	
Center 2	0	0	7	4	3	1	3	0	2	5	1	3	4	1	3	3	4	2	3	7	0	8	3	0	77
Center 3	0	0	0	4	3	3	0	3	4	6	3	0	3	3	1	1	1	0	0	1	1	0	0	0	37
Center 4	0	0	0	0	0	0	0	0	0	0	0	0	0	0	0	0	0	0	1	0	0	0	0	0	4
Center 5	0	0	0	0	0	0	0	0	0	0	0	0	1	4	1	0	0	0	0	2	0	2	0	0	10
Center 6	2	2	2	4	1	3	3	2	4	7	3	4	3	2	3	7	4	2	4	4	4	4	3	4	63
Center 7	0	0	0	0	0	3	0	0	1	3	0	0	1	1	0	0	0	0	0	1	0	0	0	0	12
Center 8	0	0	0	0	0	3	2	3	1	3	3	4	4	4	3	3	1	0	2	3	0	4	1	7	36
Center 9	0	0	1	3	3	1	3	6	2	4	3	1	4	2	2	3	3	0	0	1	0	0	1	2	43
Center 10	0	0	0	0	0	0	0	0	3	1	1	0	0	2	0	3	0	0	1	0	0	0	0	3	15
Center 11	0	0	0	4	3	0	1	4	1	1	0	0	0	0	0	0	0	0	0	0	0	0	0	0	18
Center 12	0	0	0	3	6	3	2	3	8	7	4	2	4	4	1	3	0	3	4	4	3	4	4	4	72
Center 13	0	0	0	0	0	0	0	0	0	0	0	0	0	0	0	0	0	0	1	0	1	3	0	0	10
Center 14	0	0	0	0	3	0	0	0	0	0	0	0	0	1	3	3	0	0	0	0	0	0	0	0	6
Center 15	0	0	0	0	0	2	1	1	1	2	0	3	3	1	2	1	2	1	1	3	2	1	1	3	34
Center 16	0	0	0	0	0	0	0	0	0	0	0	4	3	1	4	3	3	4	3	4	3	7	3	4	44
Center 17	3	2	2	5	5	2	3	3	3	5	3	0	2	1	3	3	2	2	1	5	2	5	1	2	63
Center 18	3	10	3	6	24	5	5	5	5	12	8	4	8	10	7	7	6	0	12	8	5	11	10	2	180
Center 19	0	0	0	0	0	0	1	1	1	3	3	3	3	2	9	0	3	4	0	4	5	3	4	3	73
Center 20	0	2	3	0	4	1	2	3	3	4	3	0	6	2	4	4	3	0	3	0	0	0	1	4	48
Total	12	16	18	31	46	31	24	43	30	66	48	37	31	43	38	46	41	13	46	14	32	47	42	44	

Cases submitted (as of 29-02-2012)

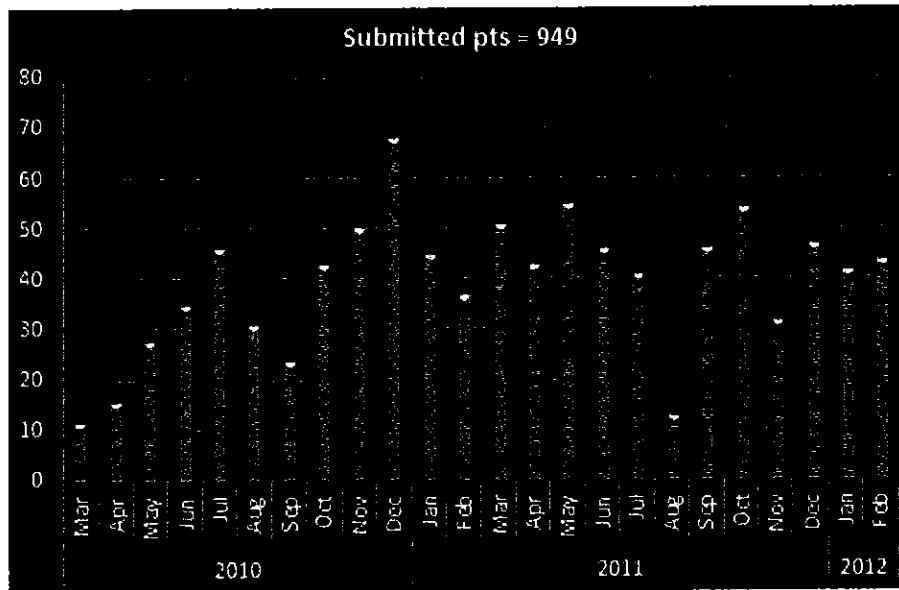

Localisation (as of 29-02-2012)

Low	416	43.8%
Low-Med	52	5.5%
Low-High	4	0.4%
Med	246	25.9%
Med-High	51	5.4%
High	171	18.0%
Not provided	9	0.9%

Modifications (as of 29-02-2012)

	Cases submitted	nr. of modified	% modified
Center 1	62	58	93.5%
Center 2	77	70	90.9%
Center 3	37	33	89.2%
Center 4	4	4	100.0%
Center 5	10	9	90.0%
Center 6	85	51	60.0%
Center 7	12	11	91.7%
Center 8	56	43	76.8%
Center 9	43	37	86.0%
Center 10	15	15	100.0%
Center 11	18	18	100.0%
Center 12	72	52	72.2%
Center 13	10	9	90.0%
Center 14	6	3	50.0%
Center 15	34	28	82.4%
Center 16	44	32	72.7%
Center 17	65	54	83.1%
Center 18	180	40	22.2%
Center 19	71	66	93.0%
Center 20	48	45	93.8%

Review outcome (as of 29-02-2012)

	58	53	3	2	0
Center 1	58	53	3	2	0
Center 2	70	50	0	9	11
Center 3	33	30	1	2	0
Center 4	4	0	0	3	1
Center 5	9	1	0	6	2
Center 6	51	48	0	1	2
Center 7	11	1	3	7	0
Center 8	43	30	0	13	0
Center 9	37	24	12	1	0
Center 10	15	12	1	1	1
Center 11	18	0	0	0	18
Center 12	52	23	0	29	0
Center 13	9	5	1	2	1
Center 14	3	2	0	0	1
Center 15	28	23	0	4	1
Center 16	32	22	3	5	2
Center 17	54	53	1	0	0
Center 18	40	22	1	17	0
Center 19	66	49	3	7	7
Center 20	45	25	0	18	2
Total	678	473	29	127	49
Total (%)	100.0%	69.8%	4.3%	18.7%	7.2%

OARs (as of 29-02-2012)**All cases****949****OAR present**

Femoral heads	747	78.7%
Bladder	855	90.1%
Small bowel	583	61.4%

- Current status
- Review procedure
- **Analysis of results**
- Conclusion

Analysis

- Analysed period: between March 2010 and September 2011
- The dataset was evaluated by a statistician -David Jegou- from the Belgian Cancer Registry



Belgian Cancer Registry

REGISTRE BELGE DES CANCERS

Gender repartition

Gender	Female	Male	Number of patients	Percentage
F	481	12450	12931	52.65
M	49	16740	16789	47.35

Age analysis

Nr	Mean	Std. Dev.	Minimum	Lower quartile	Upper quartile	Maximum	Maximum
708	55.5	7.1	55.0	55.5	55.5	55.5	55.5

TNM Classification

T	Frequency	Percent	Cumulative Frequency	Cumulative Percent
T1	1	0.22	1	0.22
T2	7	1.56	8	1.78
T3	27	5.76	35	7.54
T4	16	3.41	51	10.95
T5	7	1.50	58	12.45
T6	1	0.22	59	12.67
Frequency Missing = 0				

TNM Classification

T	Frequency (M)	Percentage	Contouring Frequency	Contouring Percentage
T0	0	0%	0	0%
T1	60	12.5%	59	98.3%
T2	101	20.8%	94	93%
T3	172	35.1%	161	93.6%
T4	17	3.5%	17	100%
Frequency Minimum = 4				

Evaluation vs. "reference" volume

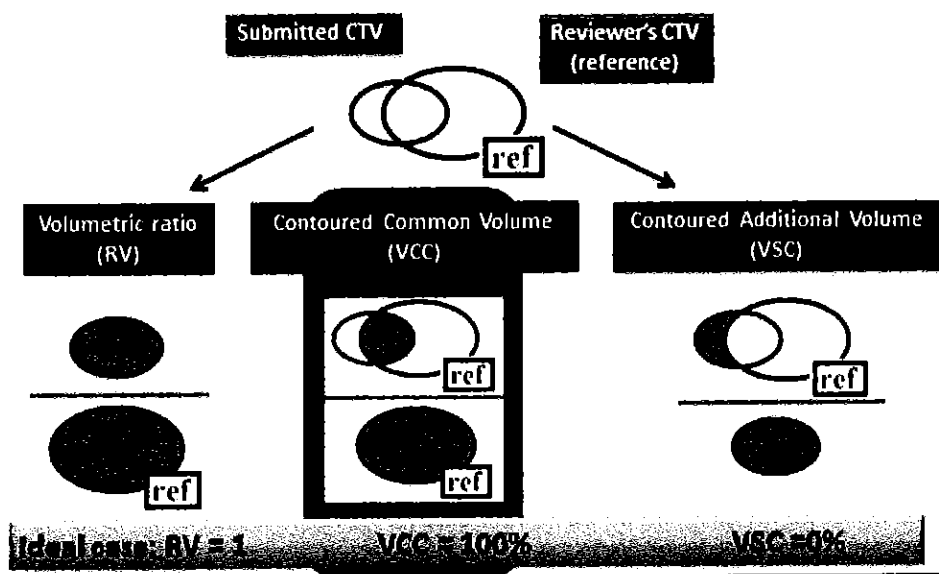

VCC by month

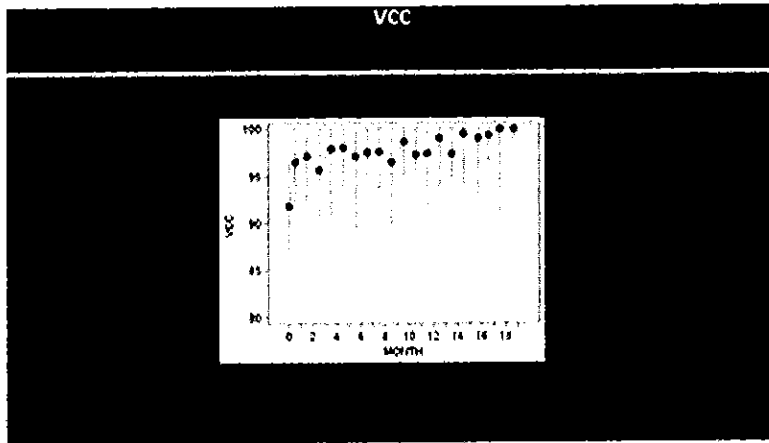

VCC by categorical patient order

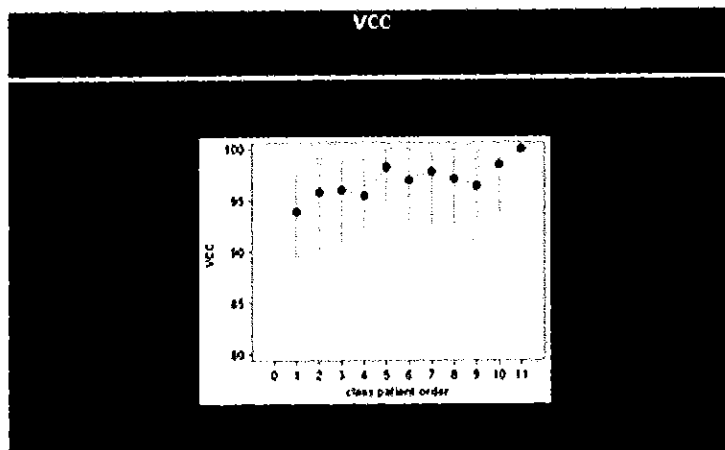

Conclusion

- PROCARE RE Project is running smoothly
- more than 900 submitted cases till now
- VCC is significantly increasing
- Difference is decreasing between the submitted and the modified CIV

3. Incident report systems

Prof. Dr. P. Scalliet
Prof. Dr. C. Weltens

ADHECO

An incident management system used for incident registration and benchmarking is proposed by Adheco (<http://www.adheco.be/>). The proposed system is the PRISMA RT system. In this system both the analysis and classification of the incidents are performed by trained personnel of the department itself, but benchmarking with other departments (national, international) is also possible.

Quality management systems (QMS)

C. WELTENS

The implementation of a Quality Management System in the Belgian Radiotherapy departments is coordinated by the College. This project consists of 3 sub-projects:

- 1) Installation of an INCIDENT REPORT SYSTEM
- 2) Participation to external dosimetry audits (see chapter about Beldart)
- 3) Participation to on site audits (organized by the college, starts in 2011)

The installation of Quality management systems is funded by the "Nationaal Kanker Plan/Plan National Cancer". This plan includes the progressive installation of a QMS in all radiotherapy departments (5 departments start each year). The QMS consists of the installation of an incident reporting system and the participation to external dosimetry audits. Furthermore on site audits are planned.

In 2011 the College prepared the preparation of the implementation of the Incident Report System. Also the first 5 hospitals were audited. External beam dosimetry was continued.

1. Installation of an incident report system: PRISMA RT

Following steps were prepared in 2011:

- A. Information to all radiotherapy departments about installation of PRISMA RT
- B. Solving the software and hardware issues

Planning for 2012

- 1) Information national meeting about the practical installation of the system is planned on March, 1st 2012
- 2) Installation of the system in all radiotherapy departments in 2012
- 3) Education of the quality coordinators
- 4) Test of the software and interface, feedback and adaptation

Planning for 2013

1. Evaluation of the system
2. Organisation of a national and international benchmark

2. On Site Audits

See separate report by Prof. Scalliet

3. External Beam dosimetry

See separate report by B. Schaeken.

4. IMRT

M. Van Dijcke

F. Vanneste

IMRT TREATMENTS IN BELGIUM SURVEYPART 2

Dear Colleagues,

The College of Radiotherapy has decided to realize a complementary survey more dedicated to the practical physics QC procedures related to the use of IMRT techniques in Belgium.

All the results will be published in the annual report of the College in an anonymous way.

The first survey was trying to evaluate the importance of IMRT for the treatments realised in Belgium and also the time dedicated for the different types of verification dedicated to this technique.

In the actual survey we would like to monitor more in details the following items:

- ▲ type of pre-treatment dosimetric verifications
- ▲ analysis methodology
- ▲ tolerances
- ▲ dedicated Linac or Machine QC (daily...)

Additionally, the radiotherapy community is very interested to have an idea of the mean number of monitors. All the information will also serve to prepare the Beldart 2 project (and to end testing)

General information

Centre:

Questionnaire filled in by (local contact):

Position:

E-mail:

Are you performing IMRT: YES NO, if no please return this page only

Do you foresee to use one of these modalities within the coming 3 years? YES NO

			If yes go to page
Modality: SMLC (Step and Shoot)	<input type="checkbox"/> Yes	<input type="checkbox"/> No	20
DMLC (Dynamic)	<input type="checkbox"/> Yes	<input type="checkbox"/> No	4
Rotational	<input type="checkbox"/> Yes	<input type="checkbox"/> No	12
Helicoïdal	<input type="checkbox"/> Yes	<input type="checkbox"/> No	28
Cyberknife	<input type="checkbox"/> Yes	<input type="checkbox"/> No	
Gammaknife	<input type="checkbox"/> Yes	<input type="checkbox"/> No	
Other	<input type="checkbox"/> Yes	<input type="checkbox"/> No	

Contents

A) DMMLC Technique (dynamic IMRT)	4
Pre-treatment verification.....	4
Point dose verification.....	4
2D Distribution.....	6
3D distributions.....	7
Tolerances for Fluence Verifications.....	8
Monitor units.....	11
B) ROTATIONAL IRMT Techniques	12
Pre-treatment verification.....	12
Point dose verifications.....	12
Distribution.....	14
3D contributions.....	15
Tolerances for Fluence Verifications.....	16
Monitor units.....	19
C) STEP-SHOOT IRMT Technique	20
Pre-treatment verification.....	20
Point dose verifications.....	20
2D Distribution.....	22
3D distributions.....	23
Tolerances for Fluence Verifications.....	24
Monitor units.....	27

D) HELICOIDAL IMRT Technique	28
Pre-treatment verification	28
Point dose verifications	28
2D Distribution	30
3D contributions	31
Tolerances for Fluence Verifications	32
Monitor units	35
E) DAILY LINAC QC DEDICATED TO IRMT	36

A) DMLC Technique (dynamic IMRT)

Pre-treatment verifications (patient oriented)

At which frequency do you perform this type of measurement?

- For no patient at all
- For some patients
- For all patients
- How many times per patient ?

a) Point dose verifications

Point doses are generally measured with an ionisation chamber in a flat phantom from gantry 0 degree for every beam (fluence) or in a geometrical or anatomical phantom from the planned gantry angles.

Do you perform point dose measurements? YES NO

If YES:

Phantom:	Flat	semi-anatomical
Type of detector used:	Detector Volume:	CC
Each field at gantry 0?	<input type="checkbox"/> YES	<input type="checkbox"/> NO
Individual field fluence control?	<input type="checkbox"/> YES	<input type="checkbox"/> NO
Dose points in homogenous dose region?	<input type="checkbox"/> YES	<input type="checkbox"/> NO
Special dose points in region of critical organs?	<input type="checkbox"/> YES	<input type="checkbox"/> NO
Total number of verified dose points/field?		
Do you use on your TPS "point doses" values or do you take into account the size of your ionisation chamber and use a mean dose value in the chamber?		
	<input type="checkbox"/> point dose	<input type="checkbox"/> mean dose

Tolerances for point dose verification results:

Localisation	Prostate	Head and Neck	Other
	Tolerance in %	Tolerance in %	Tolerance in %
Individual Fluence			
Total dose			
Organs at risk 1			
Organs at risk 2			

In case some point doses would be out of tolerance, how are you dealing with this situation?

Do you have a local protocol for this situation Yes No

If yes please summarize in few lines

Who is taking the final decision, the clinician or the physicist?

Clinician Physicist Both

b) 2D Distribution

- Are you performing fluence verifications for each patient? YES NO
- Do you analyse each field individually? YES NO
- Do you use gantry at 0 degree for each field? YES NO

Which type of measuring device are you using?

- 2D-Array system
- Gafchromic
- EDR2
- Film
- Other

Vidar:

Other scanner:

Analyzing software:

- EPID
- Portal Dosimetry
- Epiga
- Other

Are your comparisons performed in?

- Absolute dose Relative dose

In case of relative dose comparisons, do you perform an additional absolute dose control with an ionisation chamber?

- YES NO

Remarks:

c) 3D distributions

This is the case when the treatment data are transferred on a semi-anatomical phantom for combined dose distributions control.

Are you performing fluence verifications for each patient?

- YES NO

Do you acquire data for each field individually?

- YES NO

Which type of measuring device are you using?

- TLD
- 2DARRAY system
- 3 DARRAY (Delta 4, arc check)
- Film
- Other
- Chamber

Do you measure doses in?

- Coronal planes
- Transverse planes
- Sagittal planes
- Multiple planes

d) Tolerances for IMRT Verifications

The classical comparison methodology is based on the use of % of difference coupled to the DTA (distance to agreement), giving a value to the Gamma Index.

Nowadays it is not very simple to apply this concept in IMRT verifications and quite often is it difficult to compare results between different centres.

Before comparing values of Gamma Index it is important to specify some aspects of the comparison parameters.

- 1) When we will compare the calculated and the measured fluence, we will compare a quite important number of point doses and of course the dose for each point can vary a lot. Will the comparison parameters (% diff, DTA) be the same for high dose values and for low dose values? The ESTRO booklet 9 is giving some recommendations to try to resolve this problem.

Table 7.4 Proposed values of the confidence limits and action levels for IMRT treatments (from Palta *et al.*, 2003).

Region	Confidence Limit*	Action Level
High dose, low dose gradient	±1.3%	1% - 5%
High dose, high dose gradient	10% or 2mm DTA	15% or 3mm DTA
Low dose, low dose gradient	4%	7%
Dose fall off (d _{0.5,spec})	2mm DTA	3mm DTA

* The confidence limit is defined as the sum of the average deviation and 1.96 SD. The average deviation used in the calculation of confidence limit for all regions is expressed as a percentage of the prescribed dose according to the formula: $100\% \times (D_{calc} - D_{prescribed}) / D_{prescribed}$

When we will realize the comparison, we will also exclude "background" points to take into account only the representative points in the matrix. Different possibilities exist to eliminate the background.

Analysis of the results

In addition to your Gamma Index parameters (% diff, DTA), please enter your "acceptance" levels values of your clinical protocol.

Example:

Clinical Site	Prostate
Dose/DTA criterion	4% 4mm
Tolerance	98% of pixels inside the 20% isodose ROI

Institute of Physics and Engineering in Medicine, IPEM Report 96, Guidance for the Clinical Implementation of IMRT, 2008

Clinical site	Prostate	Head and Neck	Other
Dose/DTA Values			
Tolerance (% of points with gamma index ≤ 1)			
Local dose comparison (?)	YES NO	YES NO	YES NO
Maximum Weighted	YES NO	YES NO	YES NO
User value Weighted	YES NO	YES NO	YES NO
Increase tolerance/low doses	Tol: % Doses :	Tol: % Doses :	Tol: % Doses :
Background Subs.	Value : %	Value : %	Value : %
Use of a dose threshold to eliminate low dose points	YES NO	YES NO	YES NO
Increasing % tolerance for low dose points	YES NO	YES NO	YES NO
Do you take into account the points outside the path of the leaves?	YES NO	YES NO	YES NO
Use of a dose threshold to eliminate low dose points	YES NO	YES NO	YES NO
Increasing % tolerance for low dose points	YES NO	YES NO	YES NO
Do you take into account the points outside the path of the leaves?	YES NO	YES NO	YES NO

*Institute of Physics and Engineering in Medicine, IPEM Report 96,
Guidance for the Clinical Implementation of IMRT, 2008*

In your clinical routine, are the proposed values of Booklet 9 (ESTRO) gamma criteria frequently used (see table below) ?

Approach	Average Gamma	Maximum gamma	% gamma ≥ 1
Acceptable	≤ 0.5	≤ 1.5	0-5 %
Need further evaluation	0.5-0.6	1.5-2.0	5-10%
Not acceptable	≥ 0.6	≥ 2.0	$\geq 10\%$

Table 7.5 Criteria for acceptability of gamma evaluation of pre-treatment verification of IMRT beams (from Stock et al., 2005)

Your answer: YES NO

Comment:

If no:

e) Monitor units

The purpose of this question is to try to have an idea of the number of monitor units delivered for specific localisations in the different centres in Belgium.

We would like to obtain a mean value for the specified treatments.

To give us the possibility to perform a comparison, it is very important to provide some information regarding beam calibration.

Which photon energy is used for IMRT?

MU reference conditions: 1 MU = 1 cGy at SSD = cm
DEPTH = cm

Localisation	Technique: Dynamic	Typical Number of MU for 2 Gy at Ref. Point
Prostate		
Brain (no stereo)		
Head and Neck		

B) ROTATIONAL IMRT Technique

Type of technique: RapidArc VMAT Other

Do you treat all your IMRT patients with ArcTherapy? YES NO

IF NO, which localisations are dedicated for this technique?

Localisations:

Pre-treatment verifications (patient oriented)

At which frequency do you perform this type of measurement?

- For no patient at all
- For some patients
- For all patients
- How many times per patient ?

a) Point dose verifications

Point doses are generally measured with an ionisation chamber in a flat phantom from gantry 0 degree for every beam (fluence) or in a geometrical or anatomical phantom from the planned gantry angles.

Do you perform point dose measurements? YES NO

IF YES:

Phantom:	Flat	semi-anatomical
Type of detector used:	Detector Volume:	CC
Each field at gantry 0?	<input type="checkbox"/> YES	<input type="checkbox"/> NO
Individual field fluence control?	<input type="checkbox"/> YES	<input type="checkbox"/> NO
Dose points in homogenous dose region?	<input type="checkbox"/> YES	<input type="checkbox"/> NO

Special dose points in region of critical organs? YES NO

Total number of verified dose points/field?

Do you use on your TPS "point doses" values or do you take into account the size of your ionisation chamber and use a mean dose value in the chamber?

point dose mean dose

Tolerances for point dose verification results:

Localisation	Prostate	Head and Neck	Other
	Tolerance in %	Tolerance in %	Tolerance in %
Individual Fluence			
Total dose			
Organs at risk 1			
Organs at risk 2			

In case some point doses would be out of tolerance, how are you dealing with this situation?

Do you have a local protocol for this situation Yes No

If yes please summarize in few lines

(leave some space to write a few lines)

Who is taking the final decision, the clinician or the physicist?

Clinician Physicist Both

b) 2D Distribution

- Are you performing fluence verifications for each patient? YES NO
- Do you analyse each field individually? YES NO
- Do you use gantry at 0 degree for each field? YES NO

Which type of measuring device are you using?

- 2D-Array system
- Gafchromic
- EDR2
- Film
- Both

Vidar:

Other scanner:

Analyzing software:

- EPID
- Portal Dosimetry
- Epiga
- Other

Are your comparisons performed in?

- Absolute dose Relative dose

In case of relative dose comparisons, do you perform an additional absolute dose control with an ionisation chamber?

- YES NO

Remarks:

c) 3D distributions

This is the case when the treatment data are transferred on a semi-anatomical phantom for combined dose distributions control.

Are you performing fluence verifications for each patient?

- YES NO

Do you acquire data for each field individually?

- YES NO

Which type of measuring device are you using?

- TLD
- 2DARRAY system
- 3 DARRAY (Delta 4, arc check)
- Film
- Other
- Chamber

Do you measure doses in?

- Coronal planes
- Transverse planes
- Sagittal planes
- Multiple planes

d) Tolerances for IMRT Verifications

The classical comparison methodology is based on the use of % of difference coupled to the DTA (distance to agreement), giving a value to the Gamma Index.

Nowadays it is not very simple to apply this concept in IMRT verifications and quite often it is difficult to compare results between different centres.

Before comparing values of Gamma Index it is important to specify some aspects of the comparison parameters.

- 1) When we will compare the calculated and the measured fluence, we will compare a quite important number of point doses and of course the dose for each point can vary a lot. Will the comparison parameters (% diff, DTA) be the same for high dose values and for low dose values? The ESTRO booklet 9 is giving some recommendations to try to resolve this problem.

Table 7.4 Proposed values of the confidence limits and action levels for IMRT treatments (From Palma *et al.*, 2011)

Region	Confidence Limit*	Action Level
High dose, low dose gradient	<= 3%	<= 5%
High dose, high dose gradient	10% or 2mm DTA	15% or 3mm DTA
Low dose, low dose gradient	4%	7%
Dose fall off (low dose)	20% DTA	3mm DTA

* The confidence limit is defined as the sum of the average deviation and 1.96 SD. The average deviation used in the calculation of confidence limit for all regions is expressed as a percentage of the prescribed dose according to the formula: $100\% \times (D_{calc} - D_{meas}) / D_{prescribed}$

When we will realize the comparison, we will also exclude "background" points to take into account only the representative points in the matrix. Different possibilities exist to eliminate the background.

Analysis of the results

In addition to your Gamma Index parameters (% diff, DTA), please enter your "acceptance" levels values of your clinical protocol.

Example:

Clinical Site	Prostate
Dose/DTA criterion	4% 4mm

Tolerance	98% of pixels inside the 20% isodose ROI
-----------	--

Institute of Physics and Engineering in Medicine, IPEM Report 96, Guidance for the Clinical Implementation of IMRT, 2008

Clinical site	Prostate	Head and Neck	Other
Dose/DTA Values			
Tolerance (% of points with gamma index ≤ 1)			
Local dose comparison (?)	YES NO	YES NO	YES NO
Maximum Weighted	YES NO	YES NO	YES NO
User value Weighted	YES NO	YES NO	YES NO
Increase tolerance/low doses	Tol: % Doses :	Tol: % Doses :	Tol: % Doses :
Background Subs.	Value : %	Value : %	Value : %
Use of a dose threshold to eliminate low dose points	YES NO	YES NO	YES NO
Increasing % tolerance for low dose points	YES NO	YES NO	YES NO
Do you take into account the points outside the path of the leaves?	YES NO	YES NO	YES NO
Use of a dose threshold to eliminate low dose points	YES NO	YES NO	YES NO
Increasing % tolerance for low dose points	YES NO	YES NO	YES NO
Do you take into account the points	YES NO	YES NO	YES NO

outside the path of the leaves?			
---------------------------------	--	--	--

Institute of Physics and Engineering in Medicine, IPEM Report 96, Guidance for the Clinical Implementation of IMRT, 2008

In your clinical routine, are the proposed values of Booklet 9 (ESTRO) gamma criteria frequently used (see table below) ?

Approach	Average Gamma	Maximum gamma	% gamma ≥ 1
Acceptable	≤ 0.5	≤ 1.5	0-5 %
Need further evaluation	0.5-0.6	1.5-2.0	5-10%
Not acceptable	≥ 0.6	≥ 2.0	$\geq 10\%$

Table 7.5 Criteria for acceptability of gamma evaluation of pre-treatment verification of IMRT beams (from Stock et al., 2005)

Your answer: YES NO

Comment:

If no:

e) Monitor units

The purpose of this question is to try to have an idea of the number of monitor units delivered for specific localisations in the different centres in Belgium.

We would like to obtain a mean value for the specified treatments.

To give us the possibility to perform a comparison, it is very important to provide some information regarding beam calibration.

Which photon energy is used for IMRT?

MU reference conditions: 1 MU = 1 cGy at SSD = cm
DEPTH = cm

Localisation	Technique: Dynamic	Typical Number of MU for 2 Gy at Ref. Point
Prostate		
Brain (no stereo)		
Head and Neck		

C) STEP-SHOOT IMRT Technique

Pre-treatment verifications (patient oriented)

At which frequency do you perform this type of measurement?

- For no patient at all
- For some patients
- For all patients
- How many times per patient ?

a) Point dose verifications

Point doses are generally measured with an ionisation chamber in a flat phantom from gantry 0 degree for every beam (fluence) or in a geometrical or anatomical phantom from the planned gantry angles.

Do you perform point dose measurements? YES NO

If YES:

Phantom:	Flat	semi-anatomical
Type of detector used:	Detector Volume:	CC
Each field at gantry 0?	<input type="checkbox"/> YES	<input type="checkbox"/> NO
Individual field fluence control?	<input type="checkbox"/> YES	<input type="checkbox"/> NO
Dose points in homogenous dose region?	<input type="checkbox"/> YES	<input type="checkbox"/> NO
Special dose points in region of critical organs?	<input type="checkbox"/> YES	<input type="checkbox"/> NO
Total number of verified dose points/field?		
Do you use on your TPS "point doses" values or do you take into account the size of your ionisation chamber and use a mean dose value in the chamber?		

point dose mean dose

Tolerances for point dose verification results:

Localisation	Prostate	Head and Neck	Other
	Tolerance in %	Tolerance in %	Tolerance in %
Individual Fluence			
Total dose			
Organs at risk 1			
Organs at risk 2			

In case some point doses would be out of tolerance, how are you dealing with this situation?

Do you have a local protocol for this situation Yes No

If yes please summarize in few lines

(leave some space to write a few lines)

Who is taking the final decision, the clinician or the physicist?

Clinician Physicist Both

b) 2D Distribution

- Are you performing fluence verifications for each patient? YES NO
- Do you analyse each field individually? YES NO
- Do you use gantry at 0 degree for each field? YES NO

Which type of measuring device are you using?

- 2D-Array system
- Gafchromic
- EDR2
- Film
- Both

Vidar:

Other scanner:

Analyzing software:

- EPID
- Portal Dosimetry
- Epiga
- Other

Are your comparisons performed in?

- Absolute dose Relative dose

In case of relative dose comparisons, do you perform an additional absolute dose control with an ionisation chamber?

- YES NO

Remarks:

c) 3D distributions

This is the case when the treatment data are transferred on a semi-anatomical phantom for combined dose distributions control.

Are you performing fluence verifications for each patient?

- YES NO

Do you acquire data for each field individually?

- YES NO

Which type of measuring device are you using?

- TLD
- 2DARRAY system
- 3 DARRAY (Delta 4, arc check)
- Film
- Other
- Chamber

Do you measure doses in?

- Coronal planes
- Transverse planes
- Sagittal planes
- Multiple planes

d) Tolerances for IMRT Verifications

The classical comparison methodology is based on the use of % of difference coupled to the DTA (distance to agreement), giving a value to the Gamma Index.

Nowadays it is not very simple to apply this concept in IMRT verifications and quite often is it difficult to compare results between different centres.

Before comparing values of Gamma Index it is important to specify some aspects of the comparison parameters.

- 1) When we will compare the calculated and the measured fluence, we will compare a quite important number of point doses and of course the dose for each point can vary a lot. Will the comparison parameters (% , DTA) be the same for high dose values and for low dose values? The ESTRO booklet 9 is giving some recommendations to try to resolve this problem.

Table 7.4 Proposed values of the confidence limits and action levels for IMRT treatments (from Paltal *et al.*, 2003).

Region	Confidence Limit*	Action Level
High dose, low dose gradient	7-3%	10-5%
High dose, high dose gradient	10% or 2mm DTA	15% or 3mm DTA
Low dose, low dose gradient	4%	7%
Dose fall off (dose rate)	2mm DTA	3mm DTA

* The confidence limit is defined as the sum of the average deviation and 1.96 SD. The average deviation used in the calculation of confidence limit for all regions is expressed as a percentage of the prescribed dose according to the formula: $100\% \times (D_{calc} - D_{meas}) / D_{prescribed}$.

When we will realize the comparison, we will also exclude "background" points to take into account only the representative points in the matrix. Different possibilities exist to eliminate the background.

Analysis of the results

In addition to your Gamma Index parameters (% diff, DTA), please enter your "acceptance" levels values of your clinical protocol.

Example:

Clinical Site	Prostate
Dose/DTA criterion	4% 4mm

Tolerance	98% of pixels inside the 20% isodose ROI
-----------	--

Institute of Physics and Engineering in Medicine, IPEM Report 96, Guidance for the Clinical Implementation of IMRT, 2008

Clinical site	Prostate	Head and Neck	Other
Dose/DTA Values			
Tolerance (% of points with gamma index ≤ 1)			
Local dose comparison (?)	YES NO	YES NO	YES NO
Maximum Weighted	YES NO	YES NO	YES NO
User value Weighted	YES NO	YES NO	YES NO
Increase tolerance/low doses	Tol: % Doses :	Tol: % Doses :	Tol: % Doses :
Background Subs.	Value : %	Value : %	Value : %
Use of a dose threshold to eliminate low dose points	YES NO	YES NO	YES NO
Increasing % tolerance for low dose points	YES NO	YES NO	YES NO
Do you take into account the points outside the path of the leaves?	YES NO	YES NO	YES NO
Use of a dose threshold to eliminate low dose points	YES NO	YES NO	YES NO
Increasing % tolerance for low dose points	YES NO	YES NO	YES NO
Do you take into account the points	YES NO	YES NO	YES NO

outside the path o the leaves?			
--------------------------------	--	--	--

Institute of Physics and Engineering in Medecine, IPEMReport 96, Guidance for the Clinical Implimentation of IMRT, 2008

In your clinical routine, are the proposed values of Booklet 9 (ESTRO) gamma criteria frequently used (see table below) ?

Approach	Average Gamma	Maximum gamma	% gamma ≥ 1
Acceptable	≤ 0.5	≤ 1.5	0-5 %
Need further evaluation	0.5-0.6	1.5-2.0	5-10%
Not acceptable	≥ 0.6	≥ 2.0	$\geq 10\%$

Table 7.5 Criteria for acceptability of gamma evaluation of pre-treatment verification of IMRT beams (from Stock et al., 2005)

Your answer: YES NO

Comment:

If no:

e) Monitor units

The purpose of this question is to try to have an idea of the number of monitor units delivered for specific localisations in the different centres in Belgium.

We would like to obtain a mean value for the specified treatments.

To give us the possibility to perform a comparison, it is very important to provide some information regarding beam calibration.

Which photon energy is used for IMRT?

MU reference conditions: 1 MU = 1 cGy at SSD = cm
DEPTH = cm

Localisation	Technique: Dynamic	Typical Number of MU for 2 Gy at Ref. Point
Prostate		
Brain (no stereo)		
Head and Neck		

D) HELICOIDAL IMRT Technique

Pre-treatment verifications (patient oriented)

At which frequency do you perform this type of measurement?

- For no patient at all
- For some patients
- For all patients
- How many times per patient ?

a) Point dose verifications

Point doses are generally measured with an ionisation chamber in a flat phantom from gantry 0 degree for every beam (fluence) or in a geometrical or anatomical phantom from the planned gantry angles.

Do you perform point dose measurements? YES NO

IF YES:

Phantom:	Flat	semi-anatomical
Type of detector used:	Detector Volume:	CC
Each field at gantry 0?	<input type="checkbox"/> YES	<input type="checkbox"/> NO
Individual field fluence control?	<input type="checkbox"/> YES	<input type="checkbox"/> NO
Dose points in homogenous dose region?	<input type="checkbox"/> YES	<input type="checkbox"/> NO
Special dose points in region of critical organs?	<input type="checkbox"/> YES	<input type="checkbox"/> NO
Total number of verified dose points/field?		

Do you use on your TPS "point doses" values or do you take into account the size of your ionisation chamber and use a mean dose value in the chamber?

point dose

mean dose

Tolerances for point dose verification results:

Localisation	Prostate	Head and Neck	Other
	Tolerance in %	Tolerance in %	Tolerance in %
Individual Fluence			
Total dose			
Organs at risk 1			
Organs at risk 2			

In case some point doses would be out of tolerance, how are you dealing with this situation?

Do you have a local protocol for this situation

Yes

No

If yes please summarize in few lines

(leave some space to write a few lines)

Who is taking the final decision, the clinician or the physicist?

Clinician

Physicist

Both

b) 2D Distribution

- Are you performing fluence verifications for each patient? YES NO
- Do you analyse each field individually? YES NO
- Do you use gantry at 0 degree for each field? YES NO

Which type of measuring device are you using?

- 2D-Array system
- Gafchromic
- EDR2
- Film
- Both

Vidar:

Other scanner:

Analyzing software:

- EPID
- Portal Dosimetry
- Epiga
- Other

Are your comparisons performed in?

- Absolute dose Relative dose

In case of relative dose comparisons, do you perform an additional absolute dose control with an ionisation chamber?

- YES NO

Remarks:

c) 3D distributions

This is the case when the treatment data are transferred on a semi-anatomical phantom for combined dose distributions control.

Are you performing fluence verifications for each patient?

- YES NO

Do you acquire data for each field individually?

- YES NO

Which type of measuring device are you using?

- TLD
- 2DARRAY system
- 3 DARRAY (Delta 4, arc check)
- Film
- Other
- Chamber

Do you measure doses in?

- Coronal planes
- Transverse planes
- Sagittal planes
- Multiple planes

d) Tolerances for IMRT Verifications

The classical comparison methodology is based on the use of % of difference coupled to the DTA (distance to agreement), giving a value to the Gamma Index.

Nowadays it is not very simple to apply this concept in IMRT verifications and quite often is it difficult to compare results between different centres.

Before comparing values of Gamma Index it is important to specify some aspects of the comparison parameters.

- 1) When we will compare the calculated and the measured fluence, we will compare a quite important number of point doses and of course the dose for each point can vary a lot. Will the comparison parameters (% diff, DTA) be the same for high dose values and for low dose values? The ESTRO booklet 9 is giving some recommendations to try to resolve this problem.

Table 7.4 Proposed values of the confidence limits and action levels for IMRT treatments (in *et al.*, 2003).

Region	Confidence Limit*	Action Level
High dose, low dose gradient	$\pm 3\%$	5%
High dose, high dose gradient	10% or 2mm DTA	15% or 3mm DTA
Low dose, low dose gradient	4%	7%
Dose fall off ($d_{0.5\%}$)	2mm DTA	3mm DTA

* The confidence limit is defined as the sum of the average deviation and 1.96 SD. The variation used in the calculation of confidence limit for all regions is expressed as a percentage prescribed dose according to the formula: $100\% \times (D_{calc} - D_{meas}) / D_{prescribed}$.

When we will realize the comparison, we will also exclude "background" points to take into account only the representative points in the matrix. Different possibilities exist to eliminate the background.

Analysis of the results

In addition to your Gamma Index parameters (% diff, DTA), please enter your "acceptance" levels values of your clinical protocol.

Example:

Clinical Site	Prostate
---------------	----------

Dose/DTA criterion	4% 4mm
Tolerance	98% of pixels inside the 20% isodose ROI

Institute of Physics and Engineering in Medicine, IPEM Report 96, Guidance for the Clinical Implementation of IMRT, 2008

Clinical site	Prostate	Head and Neck	Other
Dose/DTA Values			
Tolerance (% of points with gamma index ≤ 1)			
Local dose comparison (?)	YES NO	YES NO	YES NO
Maximum Weighted	YES NO	YES NO	YES NO
User value Weighted	YES NO	YES NO	YES NO
Increase tolerance/low doses	Tol: % Doses :	Tol: % Doses :	Tol: % Doses :
Background Subs.	Value : %	Value : %	Value : %
Use of a dose threshold to eliminate low dose points	YES NO	YES NO	YES NO
Increasing % tolerance for low dose points	YES NO	YES NO	YES NO
Do you take into account the points outside the path of the leaves?	YES NO	YES NO	YES NO
Use of a dose threshold to eliminate low dose points	YES NO	YES NO	YES NO
Increasing % tolerance for low dose points	YES NO	YES NO	YES NO

Do you take into account the points outside the path or the leaves?	YES NO	YES NO	YES NO
---	--------	--------	--------

Institute of Physics and Engineering in Medicine, IPEM Report 96, Guidance for the Clinical Implementation of IMRT, 2008

In your clinical routine, are the proposed values of Booklet 9 (ESTRO) gamma criteria frequently used (see table below) ?

Approach	Average Gamma	Maximum gamma	% gamma ≥ 1
Acceptable	≤ 0.5	≤ 1.5	0-5 %
Need further evaluation	0.5-0.6	1.5-2.0	5-10%
Not acceptable	≥ 0.6	≥ 2.0	$\geq 10\%$

Table 7.5 Criteria for acceptability of gamma evaluation of pre-treatment verification of IMRT beams (from Stock et al., 2005)

Your answer: YES NO

Comment:

If no:

e) Monitor units

The purpose of this question is to try to have an idea of the number of monitor units delivered for specific localisations in the different centres in Belgium.

We would like to obtain a mean value for the specified treatments.

To give us the possibility to perform a comparison, it is very important to provide some information regarding beam calibration.

Which photon energy is used for IMRT?

MU reference conditions: 1 MU = 1 cGy at SSD = cm
DEPTH = cm

Localisation	Technique: Dynamic	Typical Number of MU for 2 Gy at Ref. Point
Prostate		
Brain (no stereo)		
Head and Neck		

E) DAILY LINAC QC DEDICATED TO IMRT

Are you performing IMRT linac dedicated tests every day ?

Yes

No

If yes, please give a short description of your procedure.

5. Audits

College of radiotherapy - Clinical audits 2011

Auditors

1. Clinicians: P Scalliet, Y Lievens, P Van Houtte, K Vandeputte, D Van den Weyngaert.
2. RTT: G Vandevelde, P Thysebaert, P Bijdekerke, M De Baere.
3. Physicists: MT Hoornaert, M Van Dyke, D Verellen, K Feyen, S Vynckier.

Preparation

1. Methodology

The IAEA has developed in the late 90's a methodology and a handbook for comprehensive clinical audits [1]. This was initially intended for developing countries, but soon in the early development phase, the option was taken to cover all radiotherapy programs in all settings (affluent and non-affluent countries) with all levels of technology (including IMRT). The name of the handbook is QUATRO.

Over 50 audits have been carried out in Central and Western Europe (and more across Asia, Africa and South America), allowing to validate the methodology in a variety of economical environments. This methodology is now imported in Belgium under the auspices of the college of radiotherapy.

2. Training

15 auditors have been selected by the college at the end of 2010, 5 per profession (radiation oncologist, medical physicist and nurse/radiographer) according to the IAEA audit procedure.

A training seminar has been organised by the college in March 11th and 12th in Durbuy, with 4 supervisors previously trained at IAEA and with a broad experience in auditing: Pr. S. Vynckier (medical physicists UCL), Mrs Mary Coffey (radiographer, trinity college Dublin), Mr G. Vandevelde (radiographer KUL) and Pr. P. Scalliet (radiation oncologist UCL).

All aspects of the audit structure have been covered with particular emphasis on how to communicate the audit results to the audited department and how to draft the report (a template has been provided by IAEA).

3. Organisation

The first five hospitals have been selected on the basis of the Cancer Plan project in quality assurance. These 5 hospitals were the first to benefit from the project in 2010, as they were already engaged in a certification in quality (NIAS, ISO, etc).

The head of hospitals and their quality officers were consulted for practical organisation (date).

Hospitals:

1. Verviers : 12-14 December.
Contact person: Dr Olivier De Hertog (olivier_dehertogh@hotmail.com)
RTT: *G Vandevelde*
clinician: *D Van den Weyngaert*
physicist: *D Verellen*

2. Hasselt : 25-27 January.
Contact person: Dr Paul Bulens (paul.bulens@virgajesse.be)
RTT: *G Vandevelde*
clinician: *P Scalliet*
physicist: *K Feyen*

3. ULg Sart Tilman : 14-18 November (3 days to choose).
Contact person: Prof. Philippe Coucke (pcoucke@chu.ulg.ac.be)
RTT: *P Bijdekerke*
clinician: *Y Lievens*
physicist: *M Van Dycke*

4. Namur (Ste Elisabeth): 11 – 13 janvier (3 days to choose).
Contact person: dr V. Remouchamps
(Vincent.REMOUCHAMPS@cmsenamur.be)
RTT: *G Vandevelde*
clinician: *P Van Houtte*
physicist: *D Verellen*

5. Turnhout (St Elisabeth): 12-14 December (3 days to choose).
Contact person: Dr Jean Meyskens (Jean.Meyskens@sezktturnhout.be)
RTT: *Mia De Baere*
clinician: *K Vandeputte*
physicist: *MT Hoornaert*

6. Additional audit on request from Ministry of Health of Luxemburg:
Esch-sur-Alzette: 5-7 December

RTT : *G Vandeveld*
clinician: *P Scalliet*
physicist : *S Vynckier*

Results

At the end of the audit, an audit report is delivered to each hospital (head of department). It contains a complete description of the department structure and organisation, as well as a thorough review of treatment procedures and quality assurance program. Different conclusions can be reached: (a) there are severe deficiencies that need immediate remedial action followed by a verification audit, (b) deficiencies that do not prevent the department to further operate but need rapid correctives actions, (c) non-conformities that need to be addressed before the following audit (5 years), (d) there are no recommendations and the centre is declared "centre of competence".

All 5 Belgian hospitals have been declared "centre of competence" according to the IAEA terminology. There were no deficiencies identified needing immediate or delayed corrective actions. The quality and safety of patient treatments was ensured in all sites.

The five audit reports have been discussed during an auditor meeting in April 2012. A more detailed report is in preparation.

Follow-up

The next five hospitals will be audited in the fall (October-December 2012) by the same auditors teams. It is intended to keep these teams active for several years, allowing for build-up of expertise.

References

[1] Comprehensive Audits of Radiotherapy Practice: A Tool for Quality Improvement (Quality Assurance Team for Radiation Oncology – QUATRO).